

OPTION

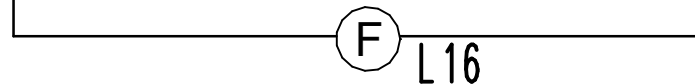

*Dieses Produkt enthält eine Lichtquelle der Energieeffizienzklasse <G>

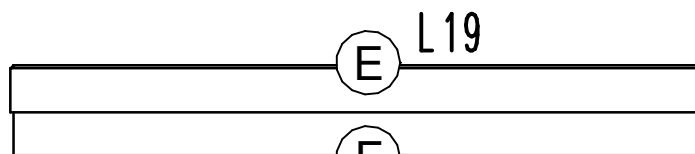
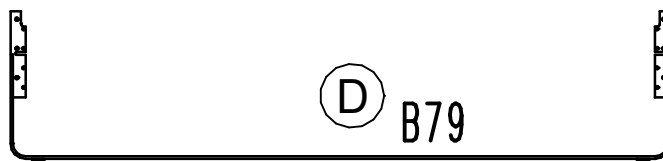
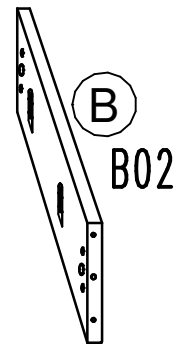
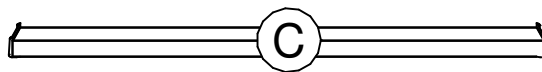
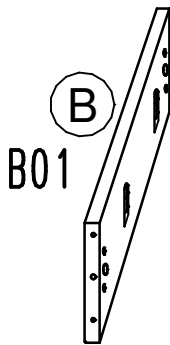
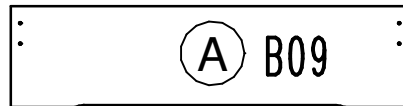

1.

631.1001.000
M 6 x 12 mm

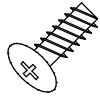

①

4 x

②

624.0027.000



2 x

631.1051.000
4 x 17 mm



③

14 x

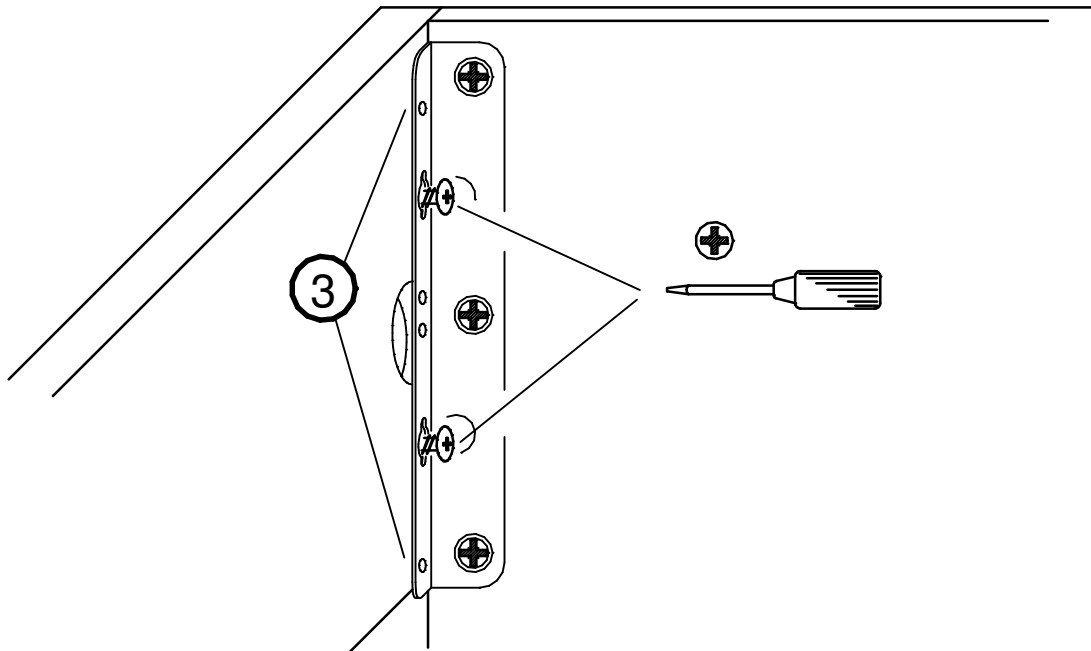
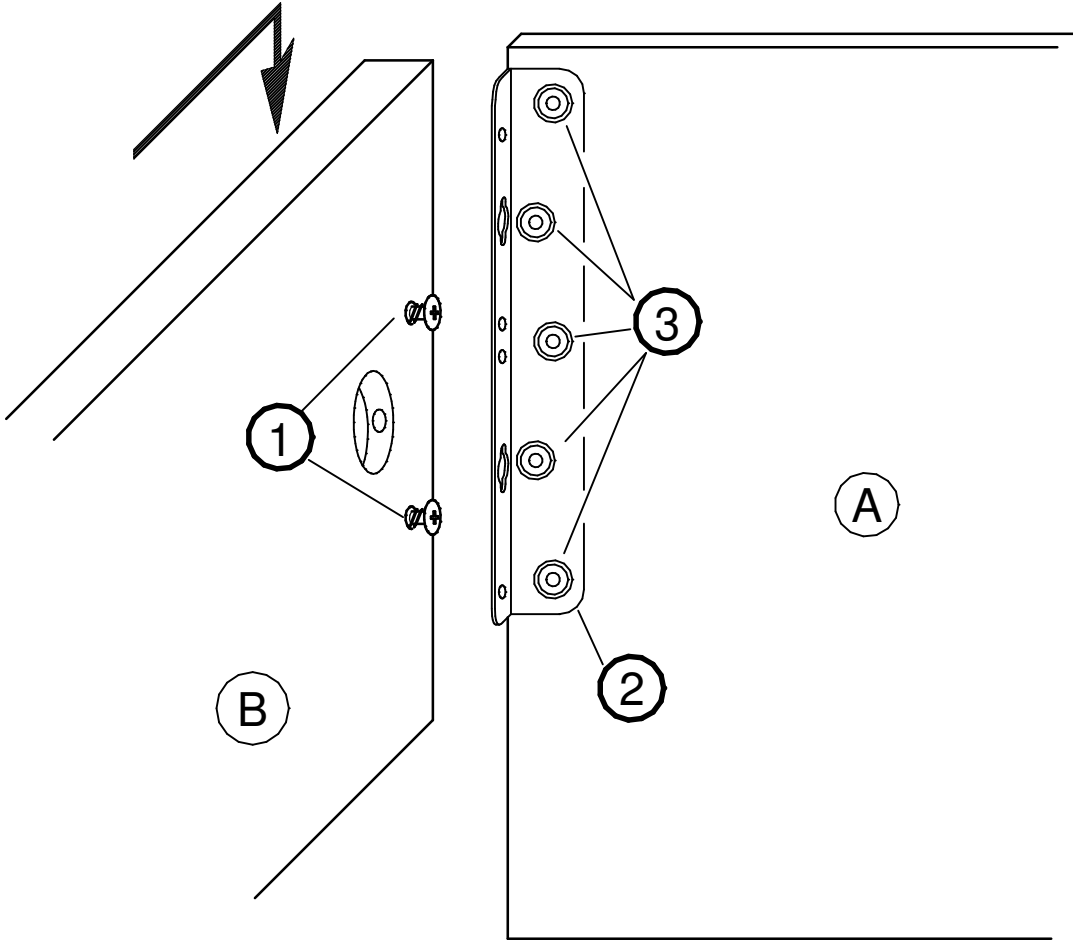

2.

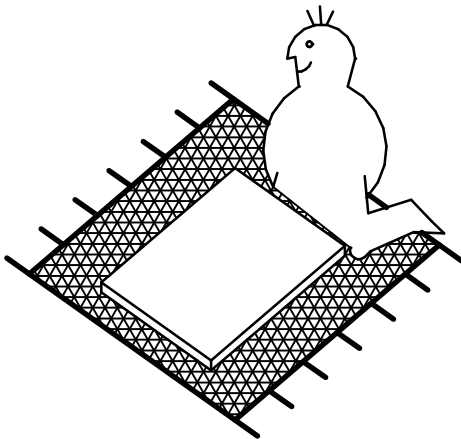
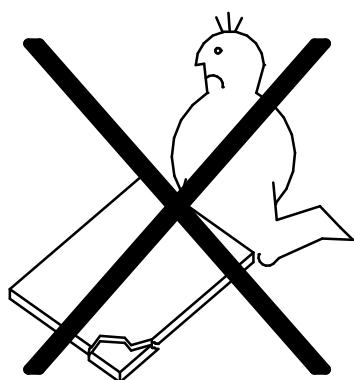

632.0567.000
6,3 x 18 mm

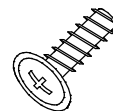

4

8 x

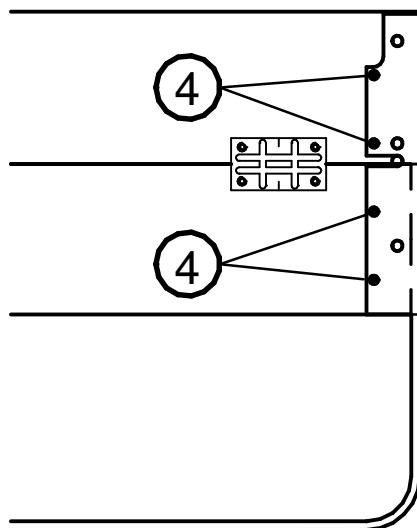
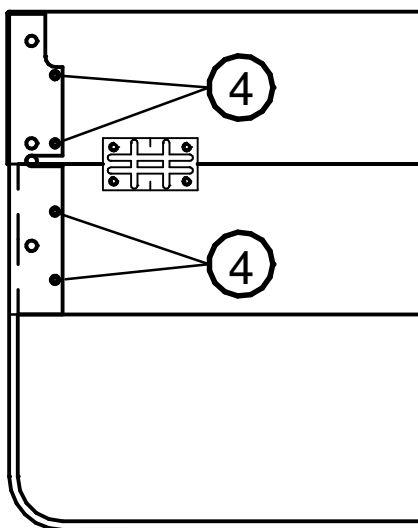
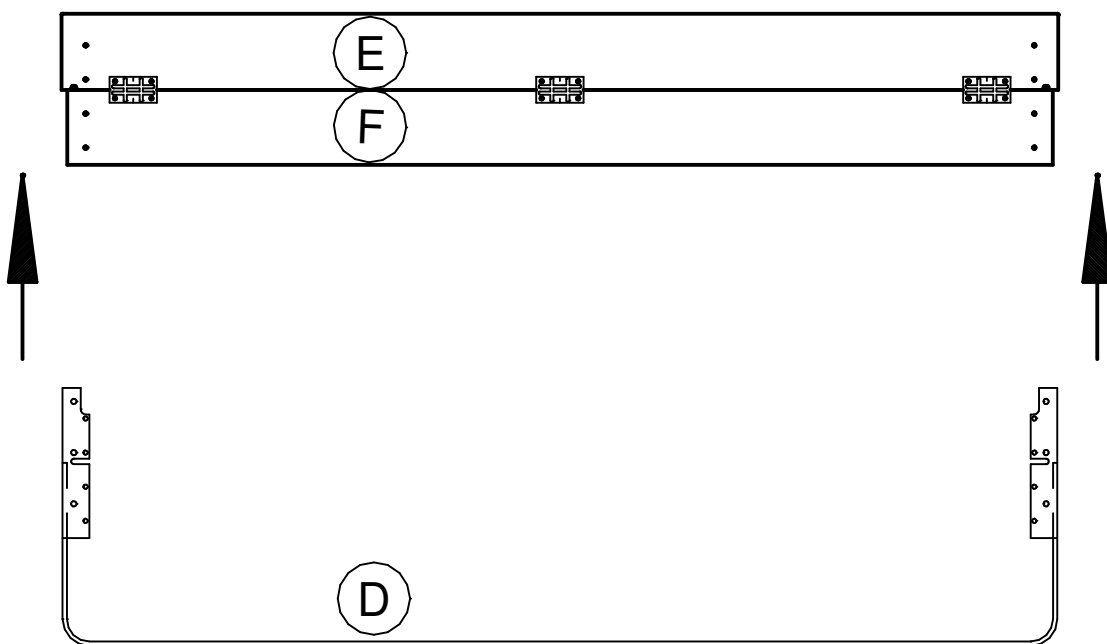

3.

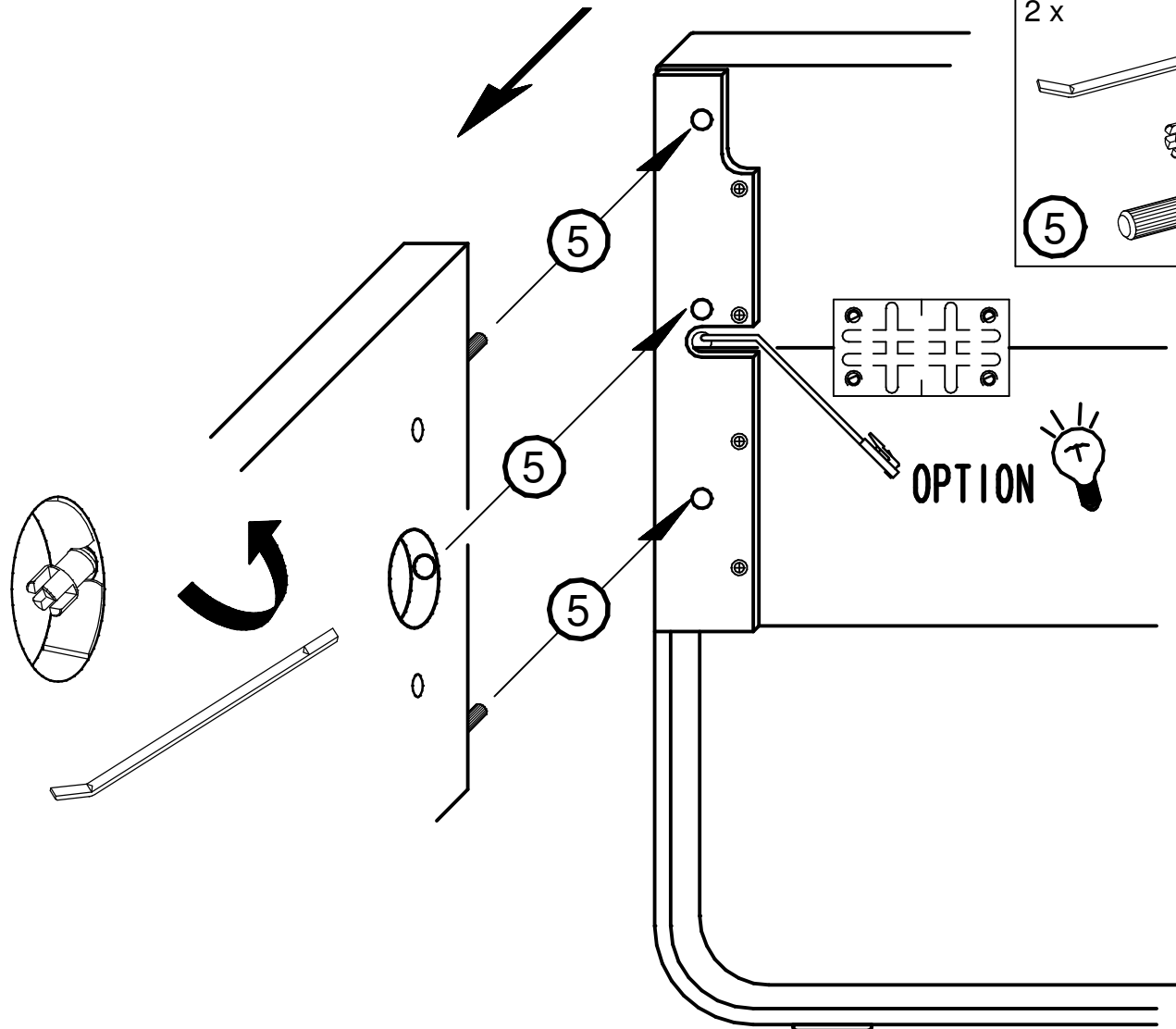
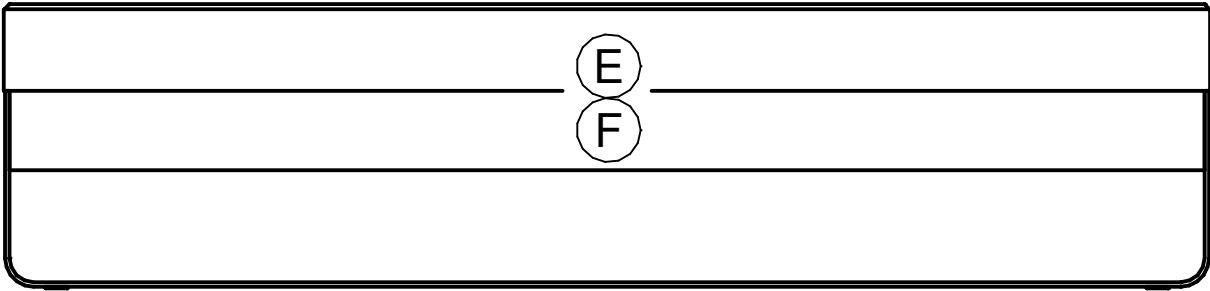
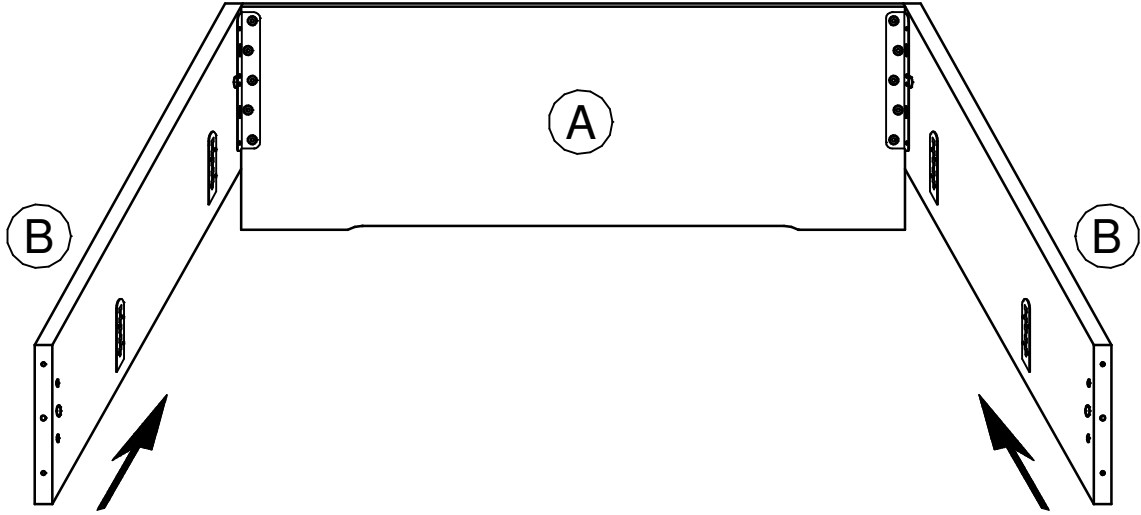

624.0090.000

2 x

5

1 x

OPTION



OPTION

644.0049.000

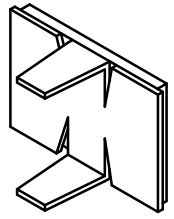

⑥

5 x

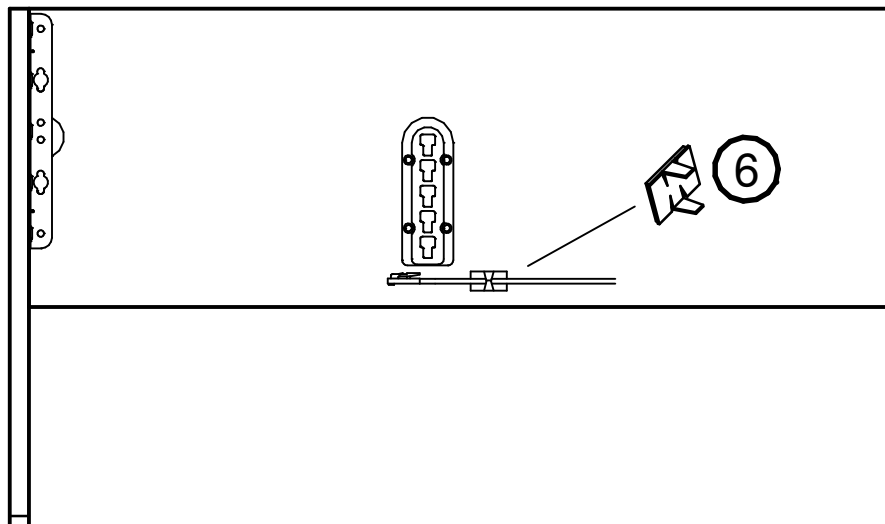
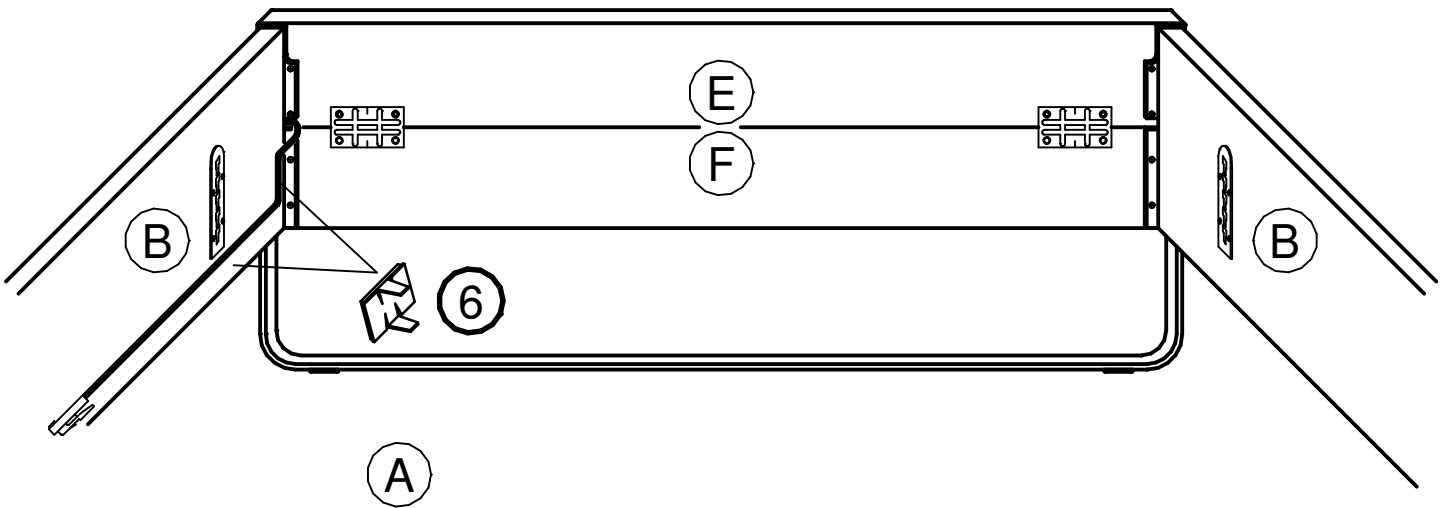
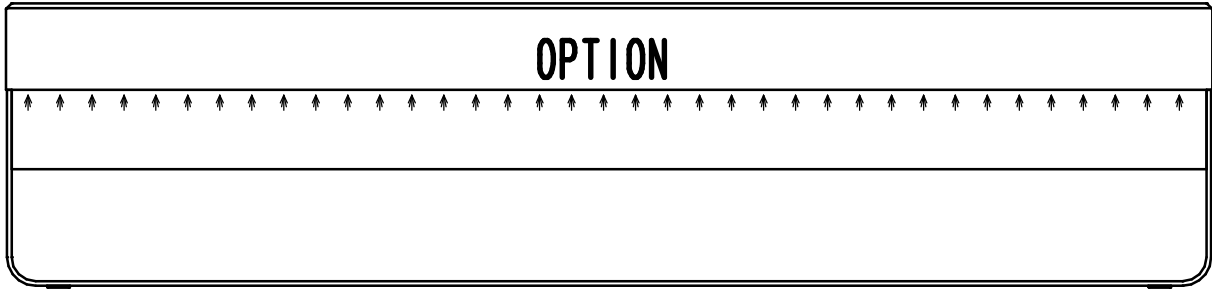

OPTION



642.9028.000

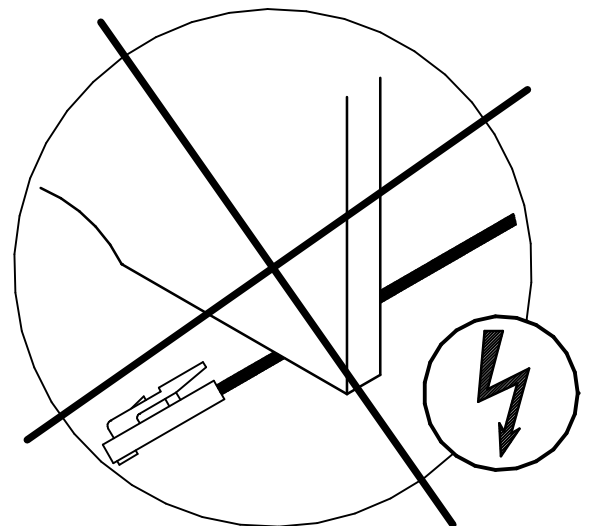
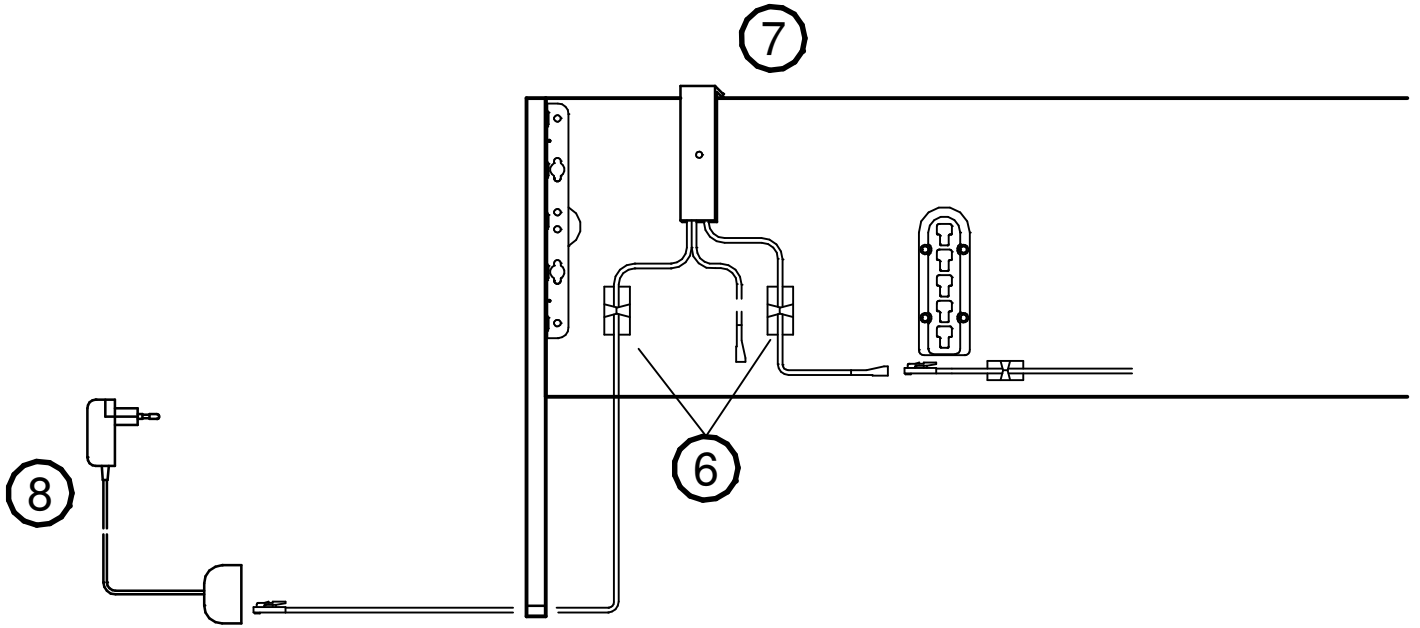
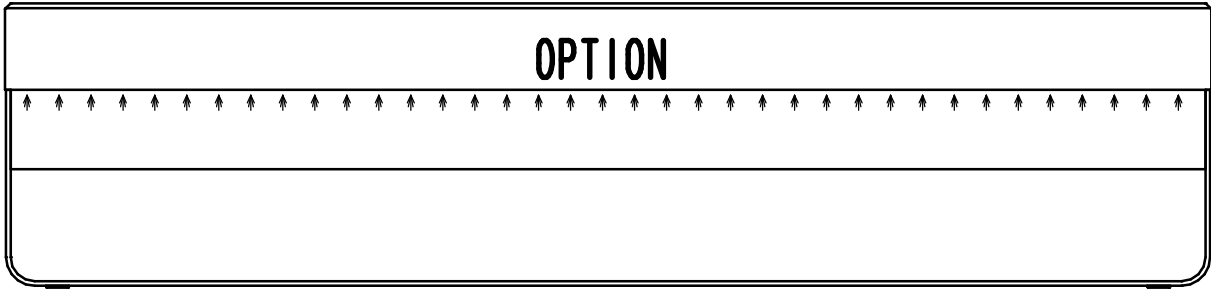
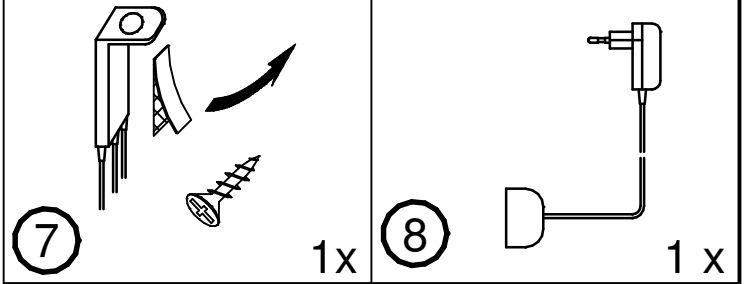

644.0184.000

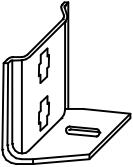

⑨ 4x

644.0180.000

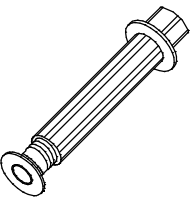

⑩ 2x

644.0243.000



⑪ 2x

644.0181.000



⑫ 2x

4.

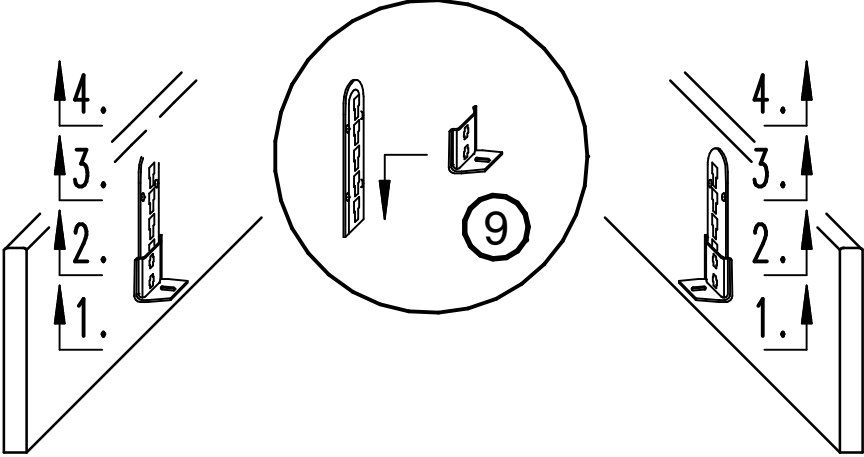

632.0550.000
M 10 x 30



⑬ 2x

632.0551.000
M 5 x 30 mm

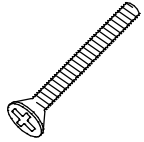

⑭ 4x

632.0548.000
M 5



⑮ 4x

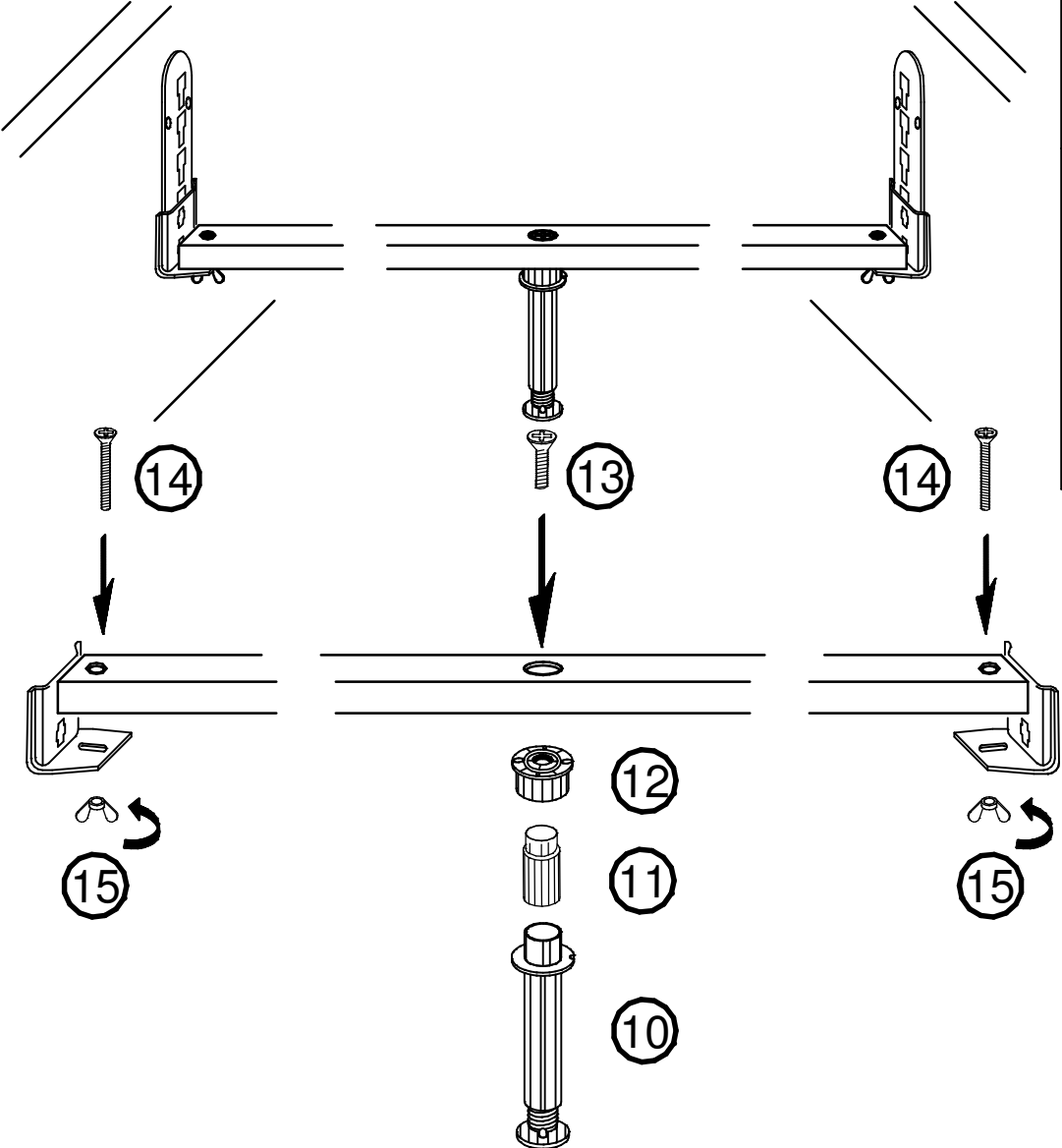

⑭ 4x

⑮ 4x

⑫ 2x

⑪ 2x

⑩ 2x

