

\*Dieses Produkt enthält eine Lichtquelle der Energieeffizienzklasse <G>

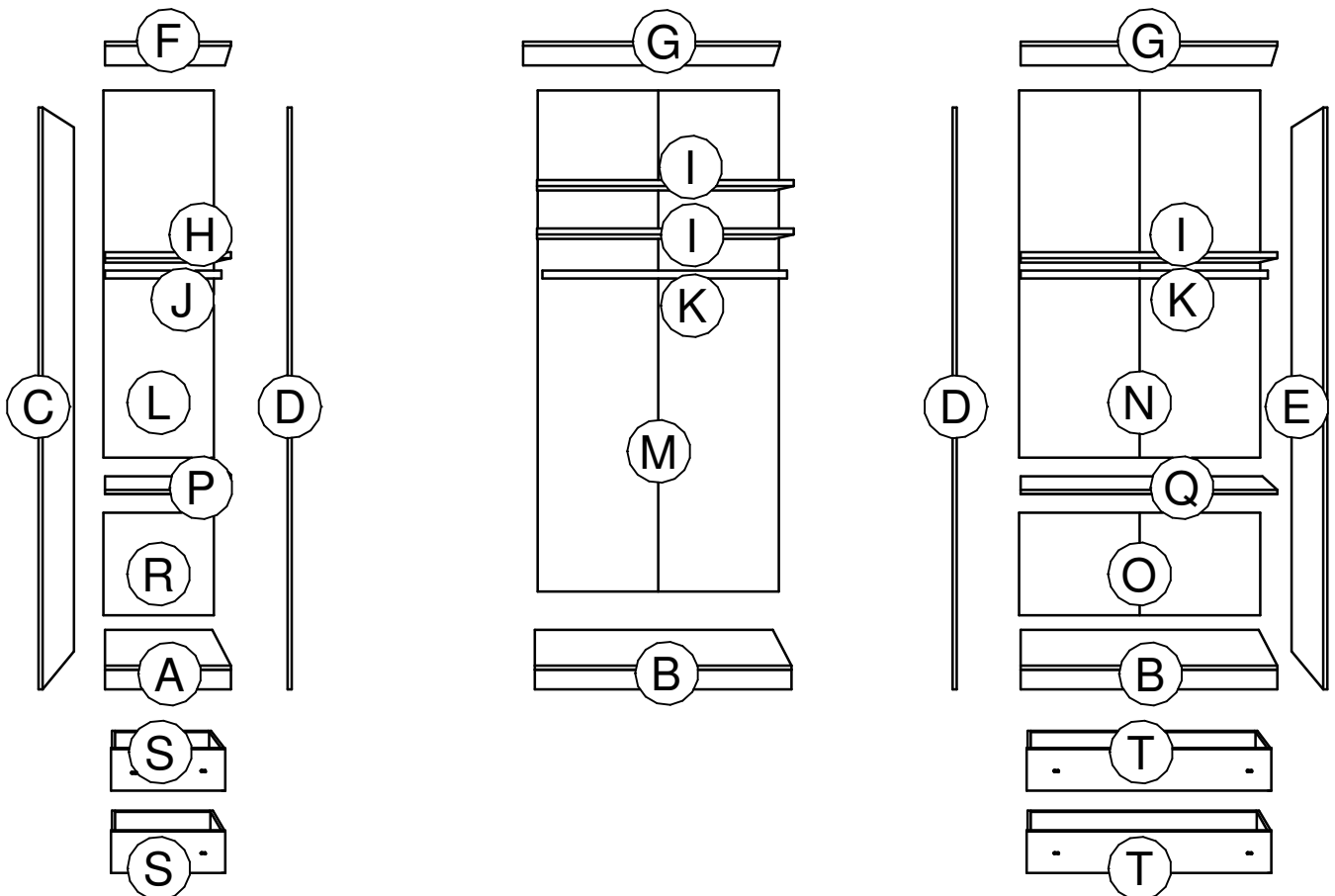



1	2	3	4

480	976	480
-----	-----	-----

1	2	3	4	5	6

976	976	976
-----	-----	-----

1.

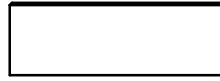
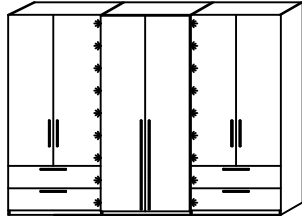
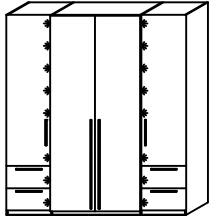

1

641.0227.000  
12 mm



2

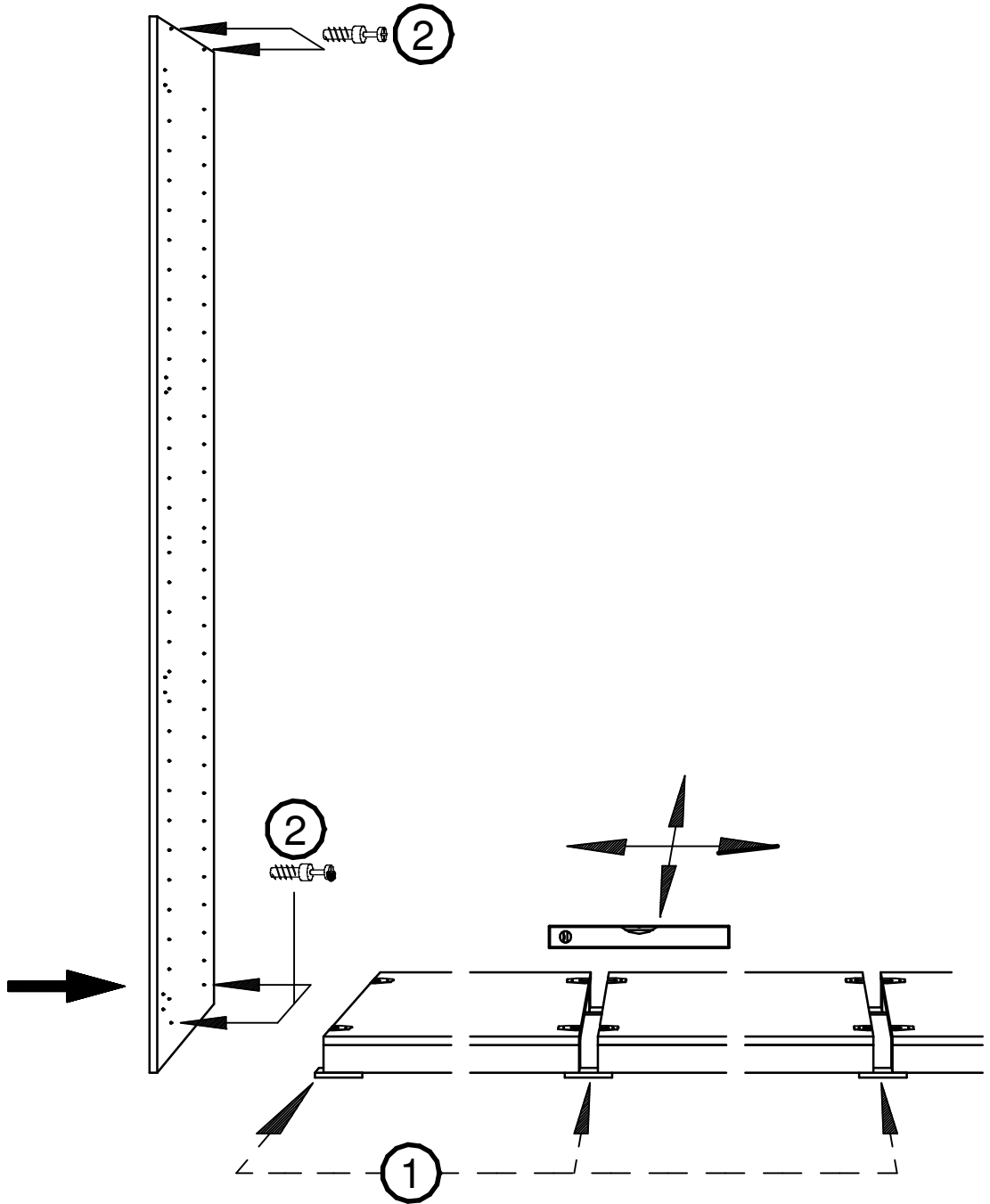

2.

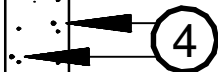
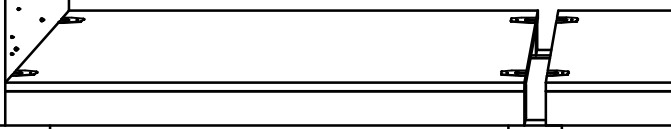
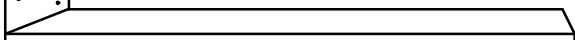
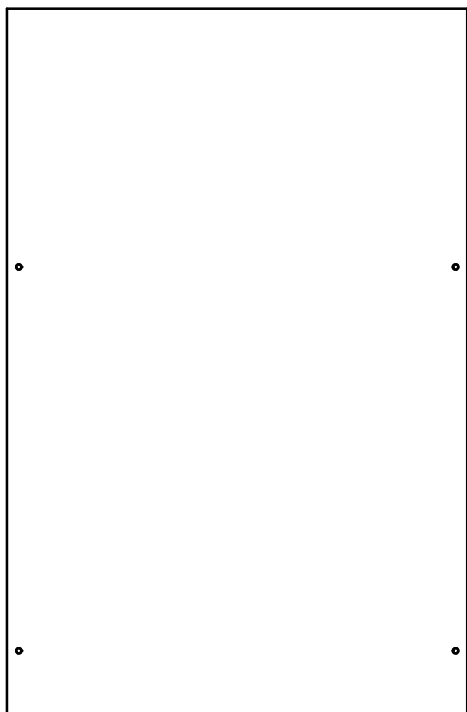
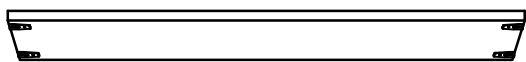

641.0226.000

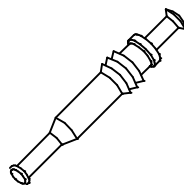

3

641.0548.000

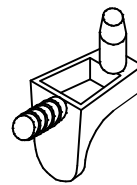

4

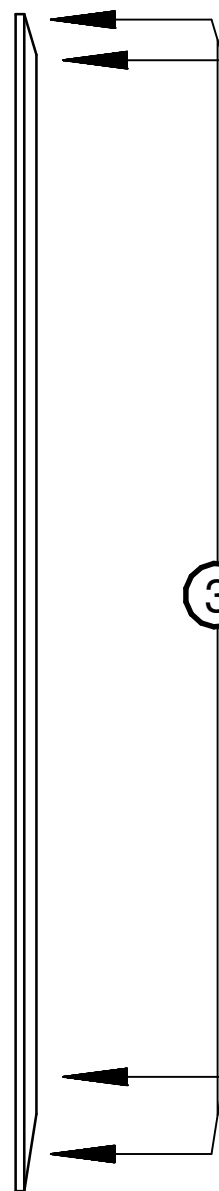

3

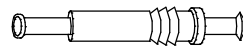

4



B

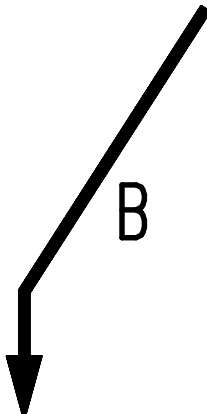

3.

621.2930.000

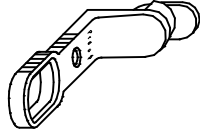

5

631.1266.000

6,3 x 11 mm



6

631.1472.000

3,5 x 15 mm



7

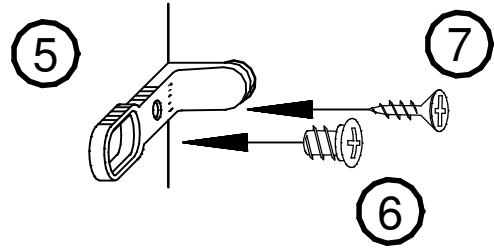
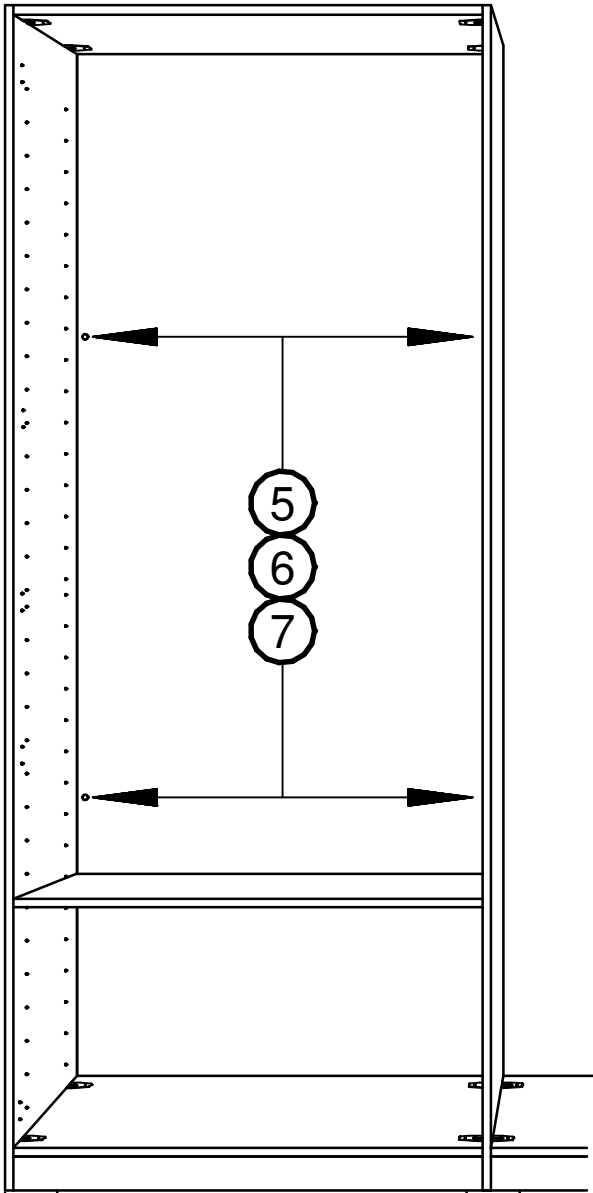

4.

641.0227.000  
12 mm

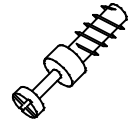

②

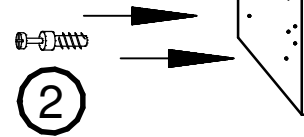
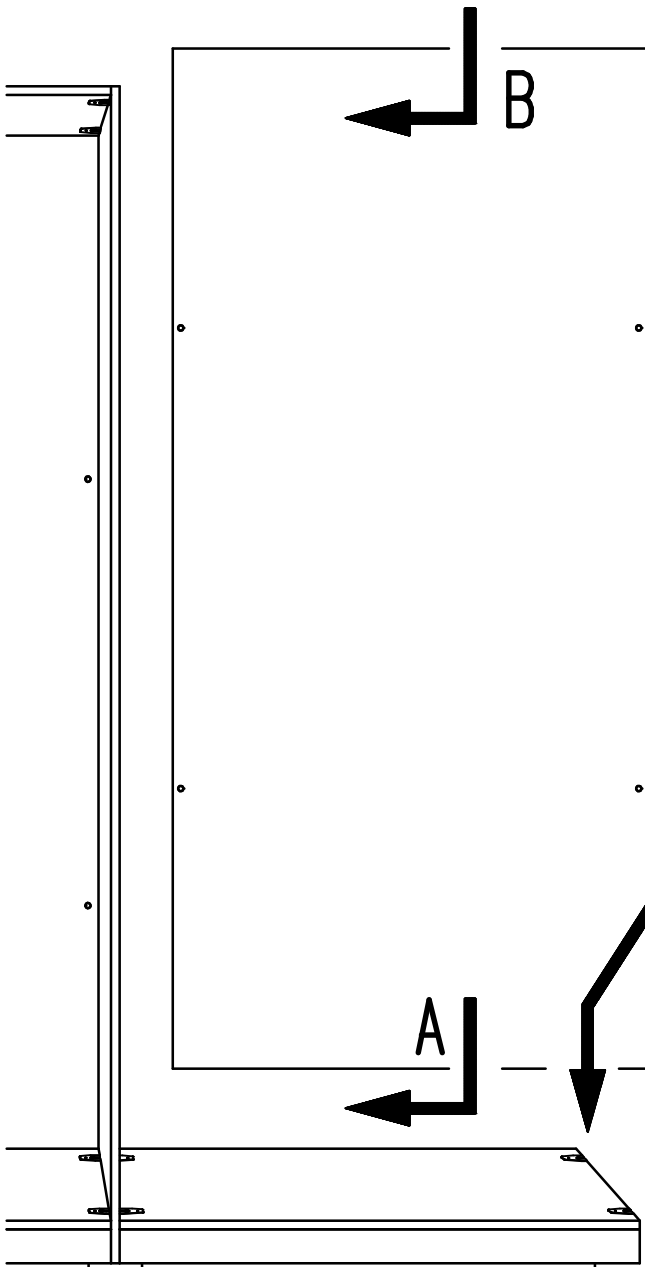
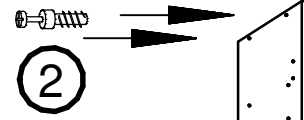
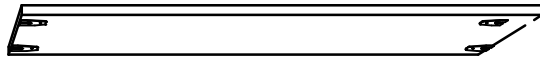
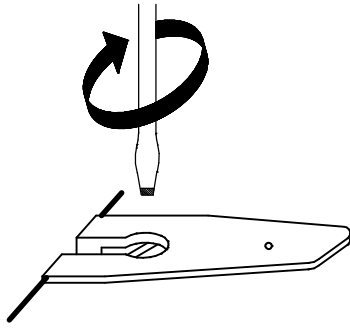

5.

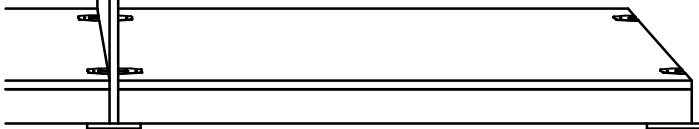
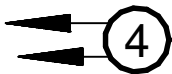
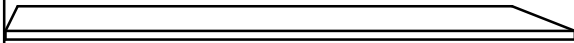
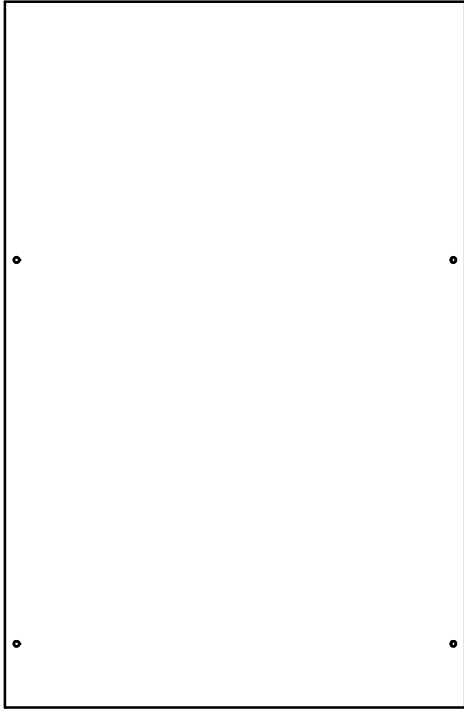
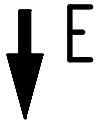
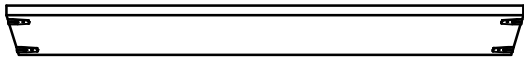

641.0227.000  
12 mm

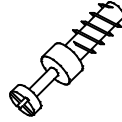

2

641.0548.000

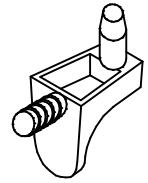

4

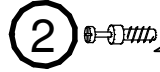

4

2

6.

621.2930.000

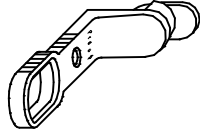

5

631.1266.000

6,3 x 11 mm



6

631.1472.000

3,5 x 15 mm



7

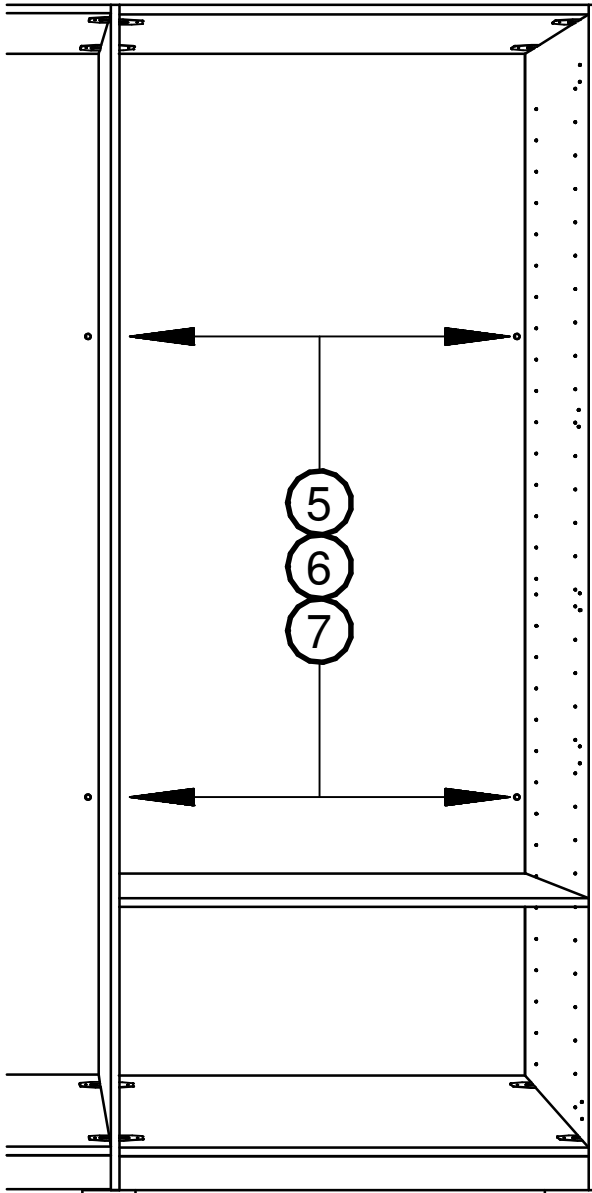
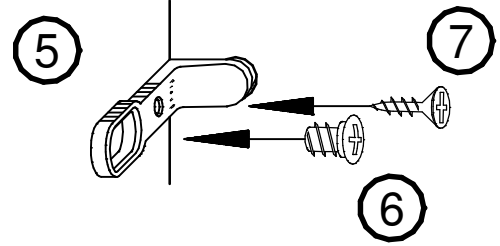



7.

641.0204.000

632.0038.000

4 x 14 mm



8

9

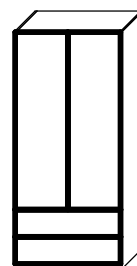
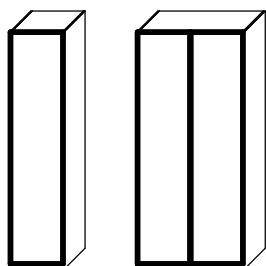
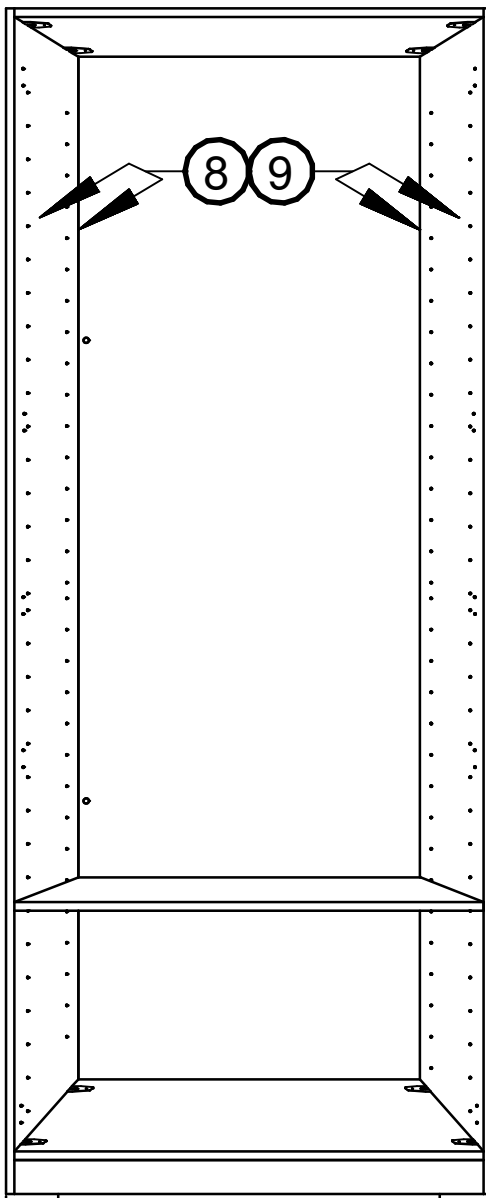
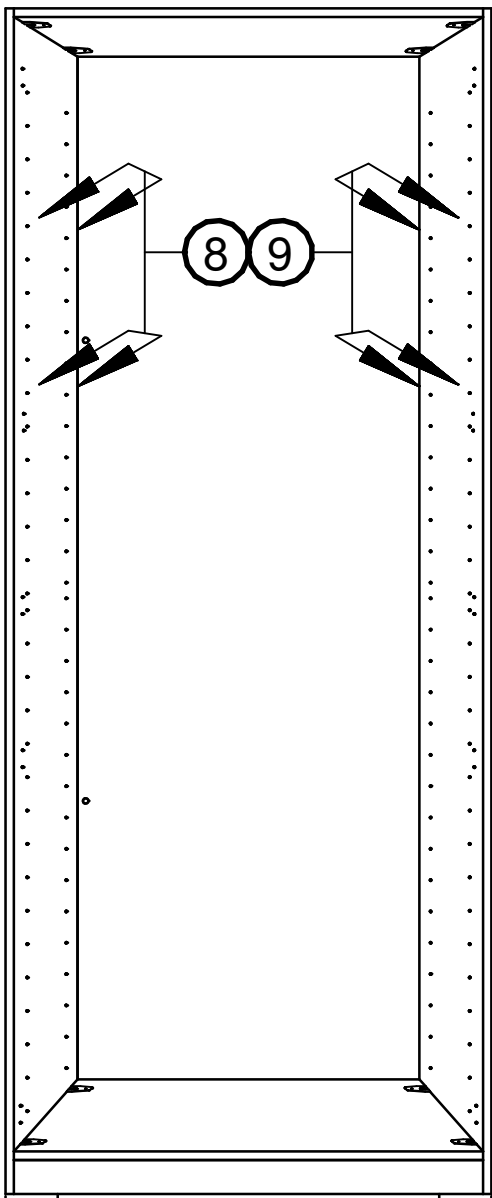

8.

631.1472.000  
3,5 x 15 mm



7

621.0067.000



10

632.0517.000  
M6 x 30 mm

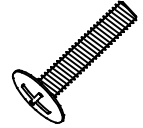

11

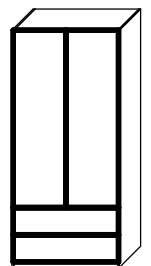
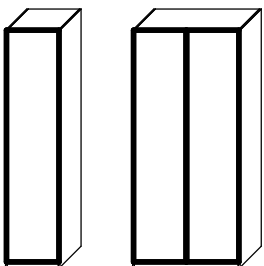
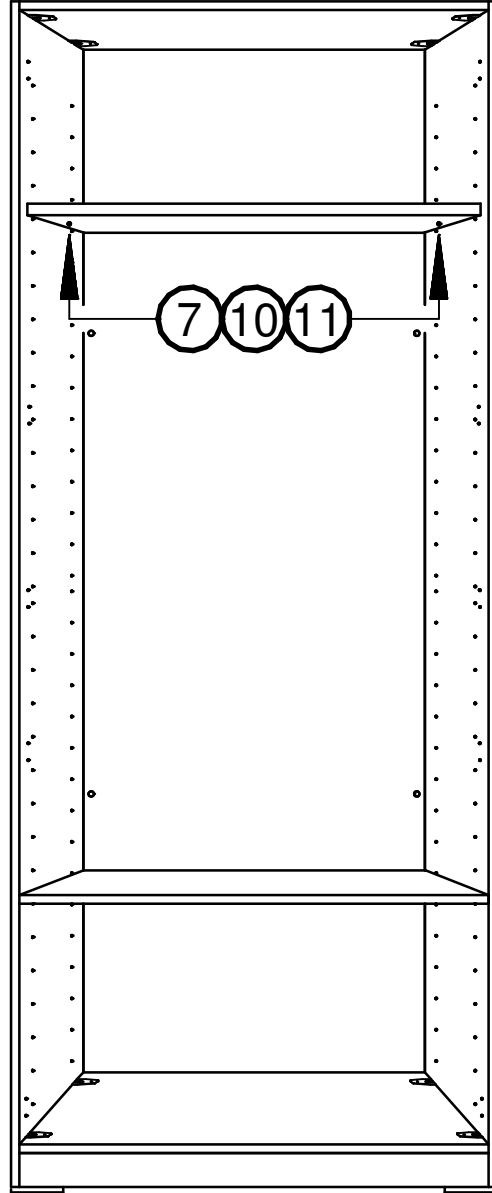
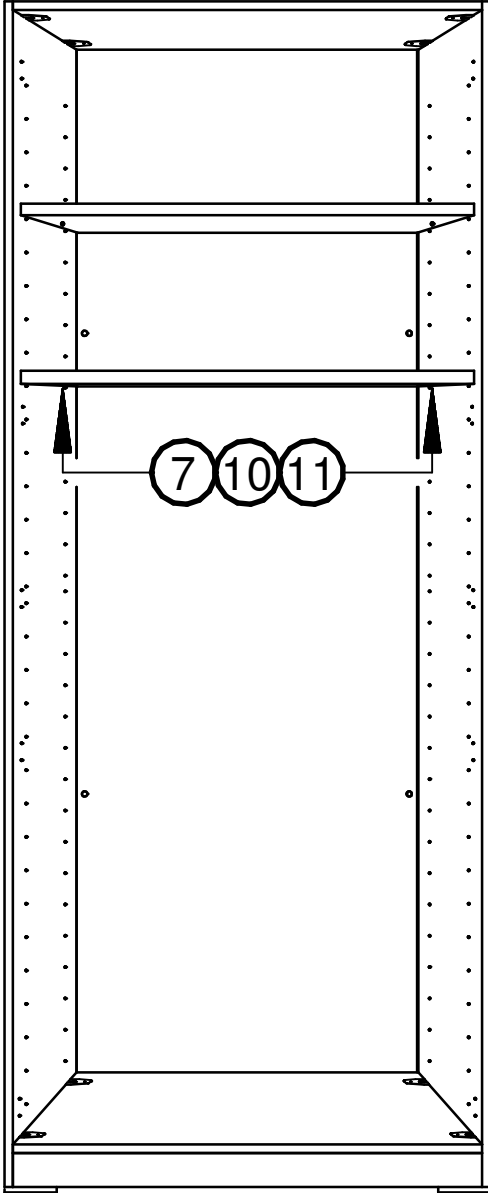

9.

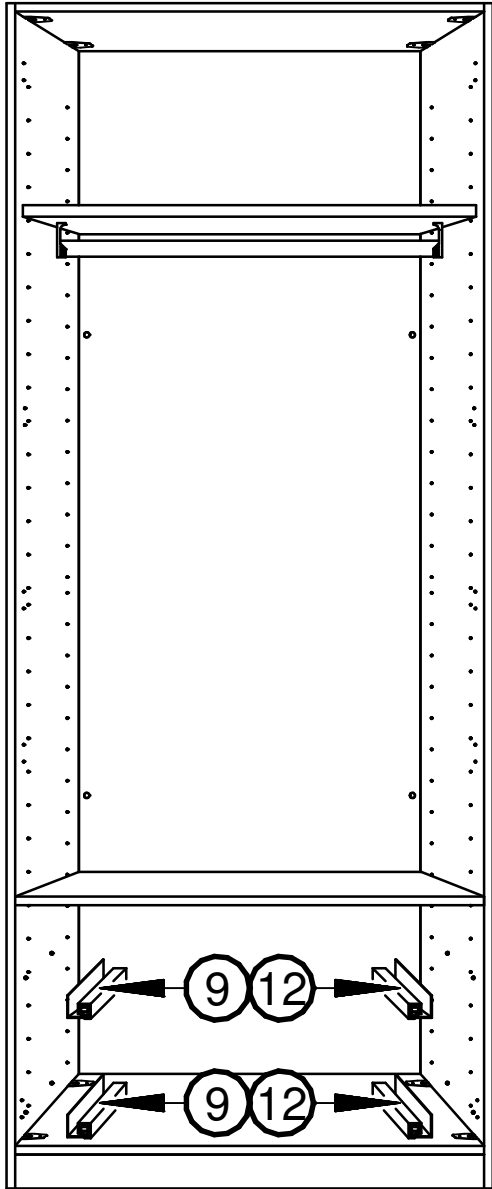

632.0038.000  
4 x 14 mm



9

632.0545.000  
6,3 x 9 mm



12

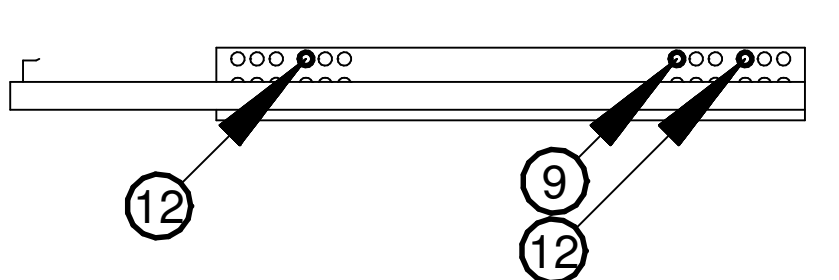
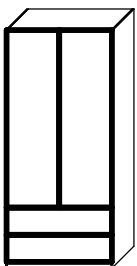
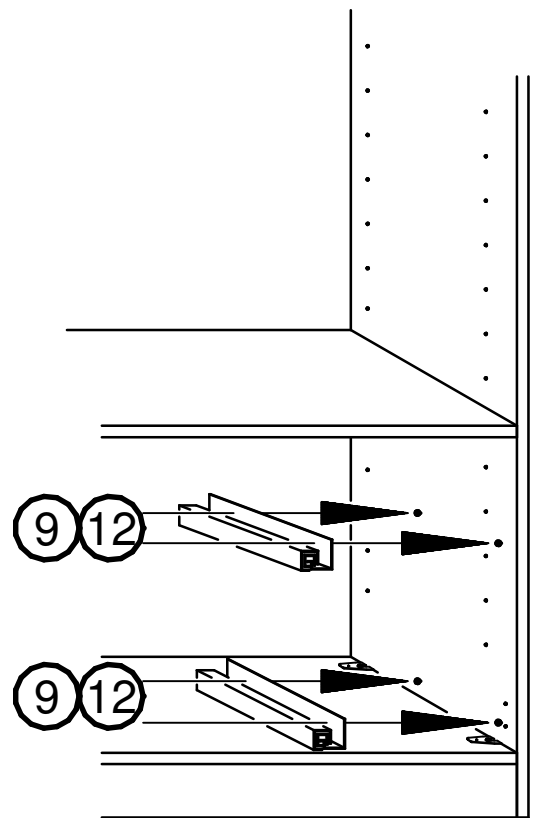

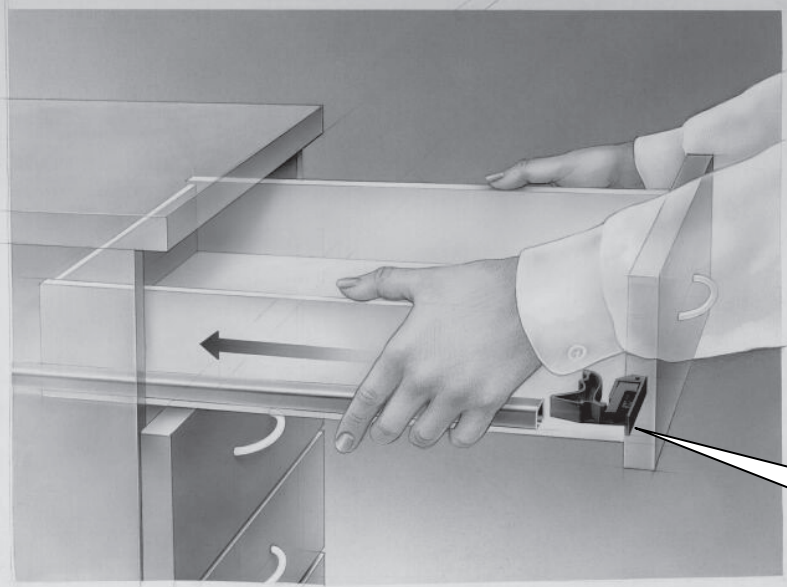

**click**

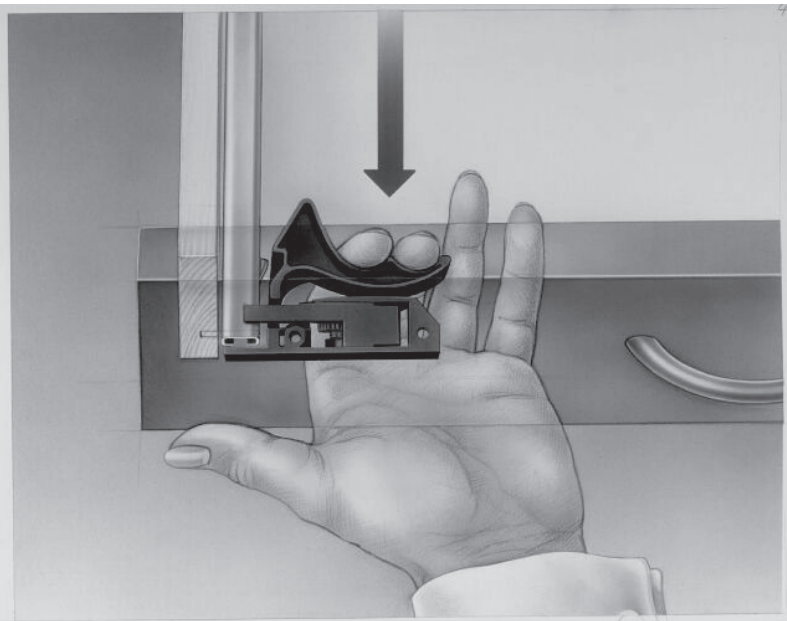
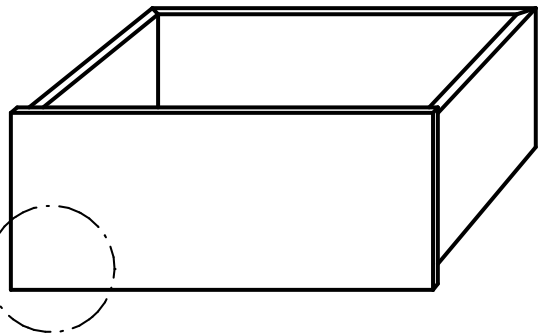
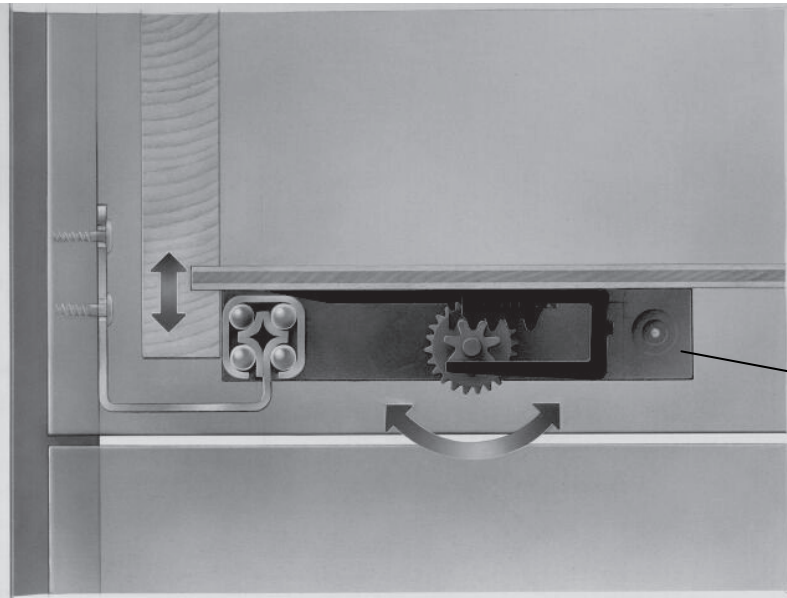

623.0054.000



13

10.

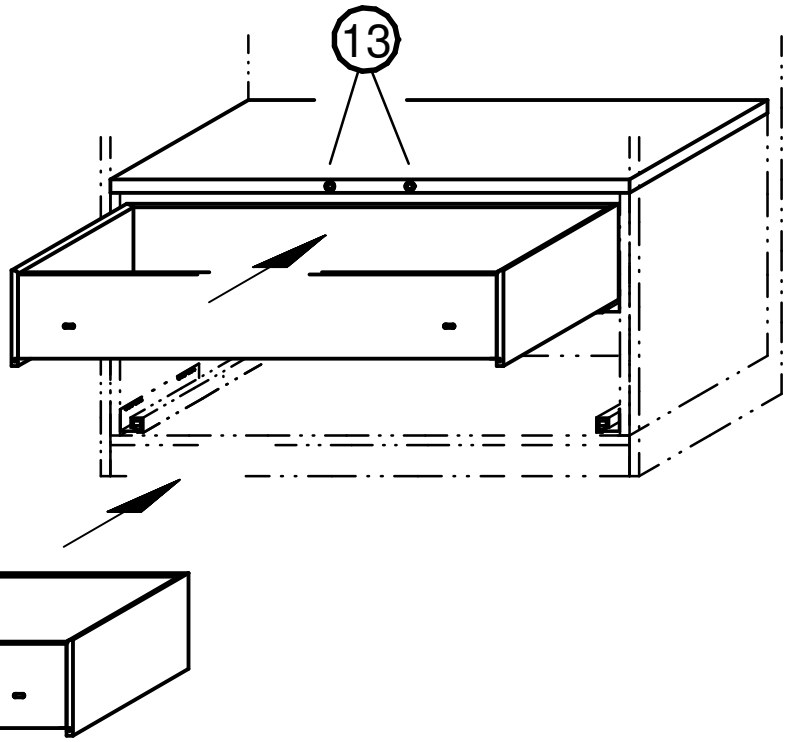

11.

632.0500.000  
M6 x 25 mm

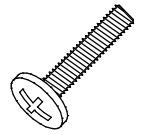

14

14

14

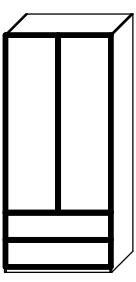
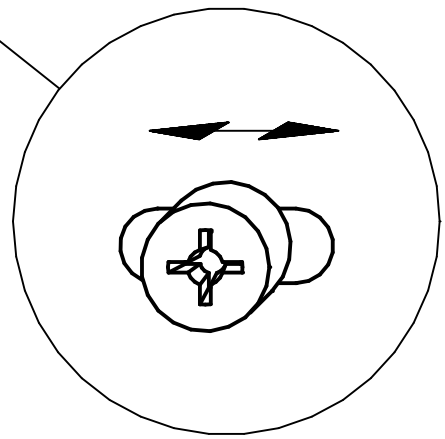
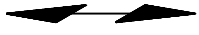
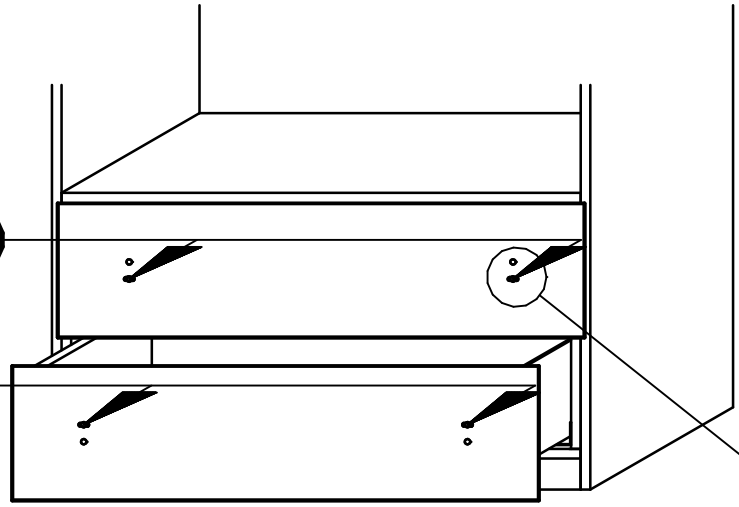

12.

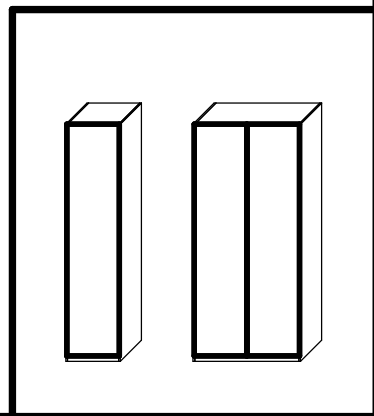
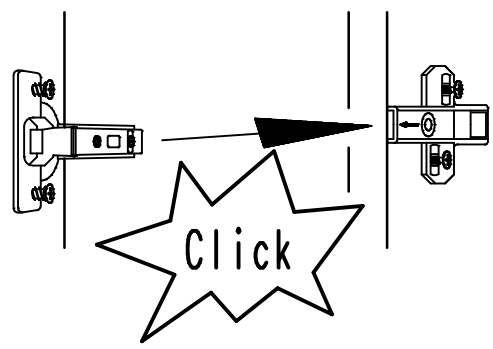
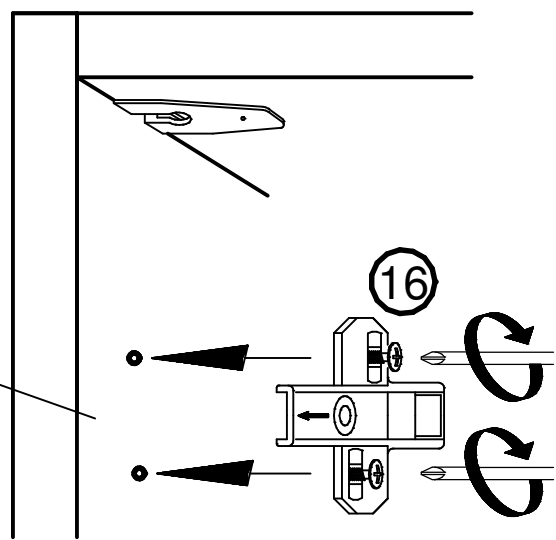
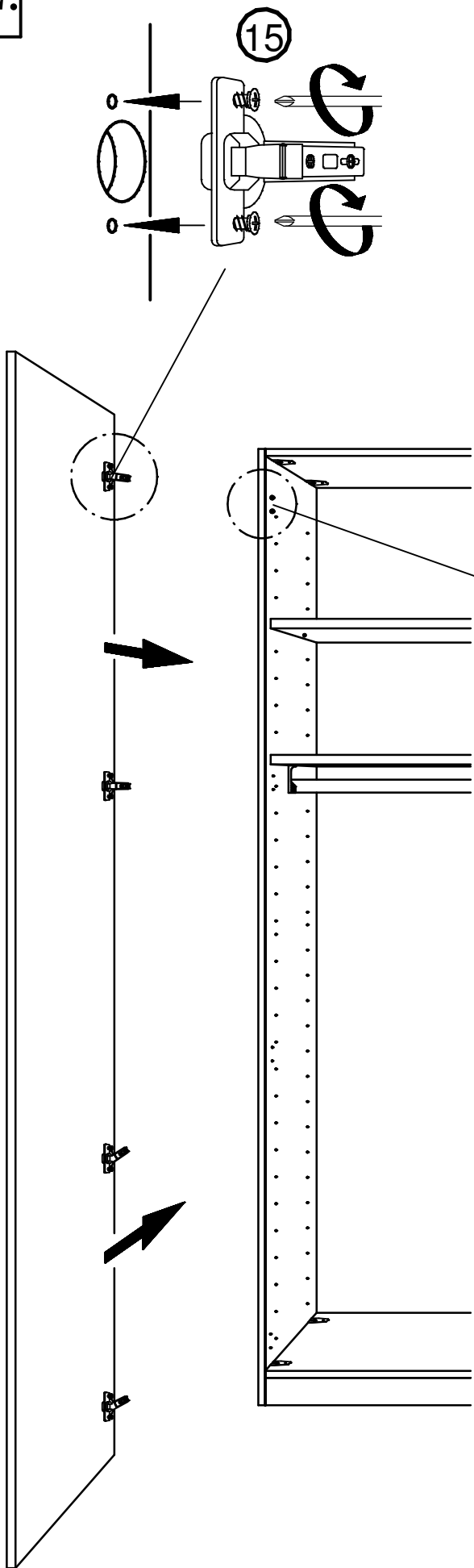
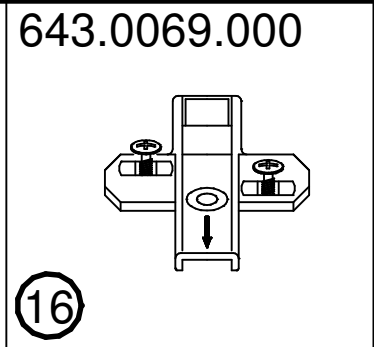
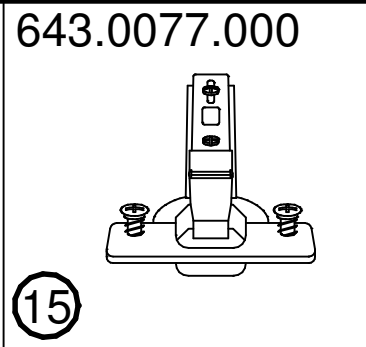

13.

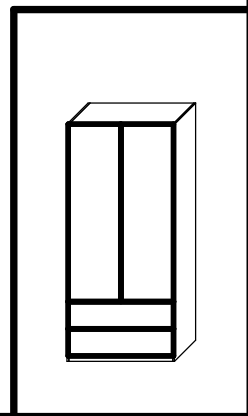
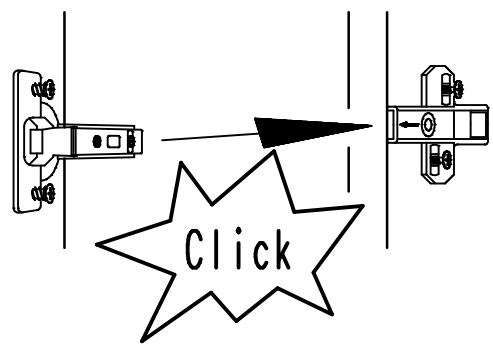
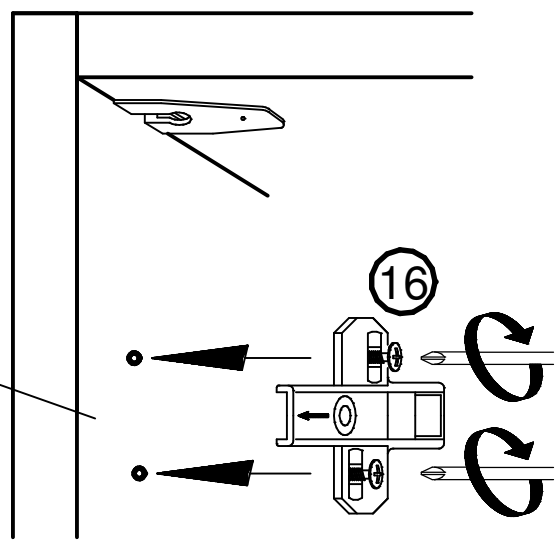
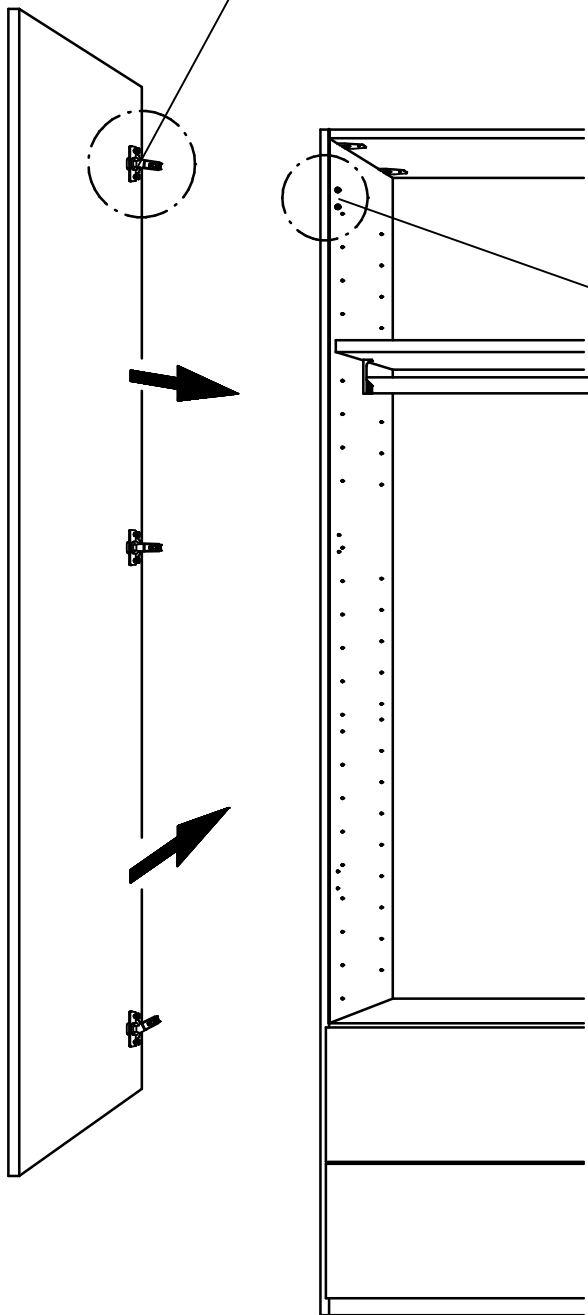
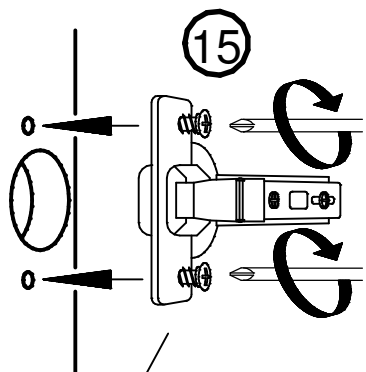
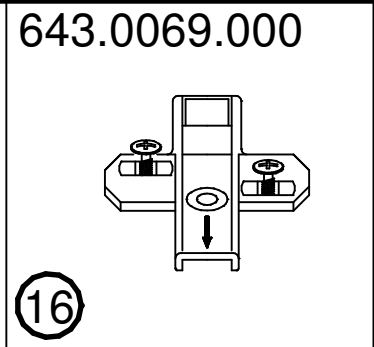
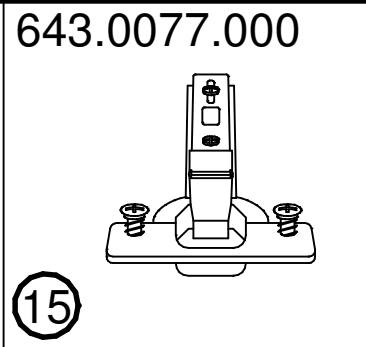

14.

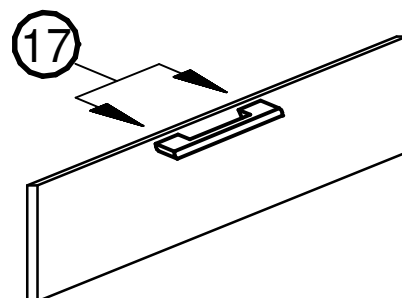
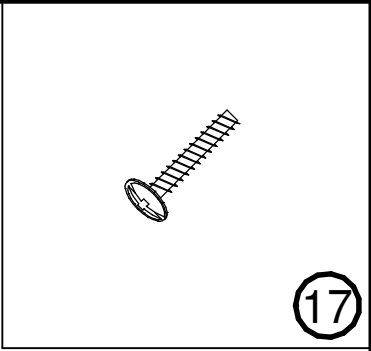
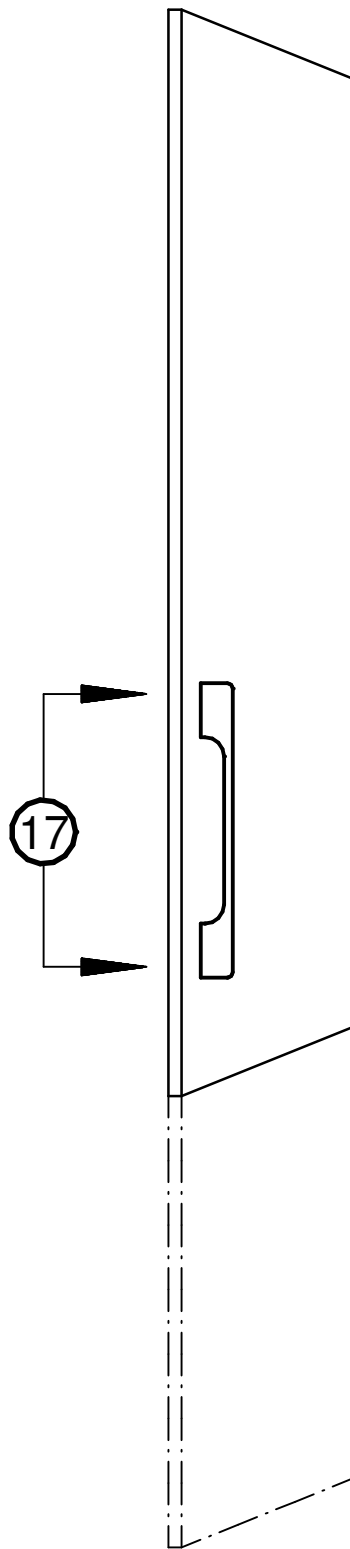
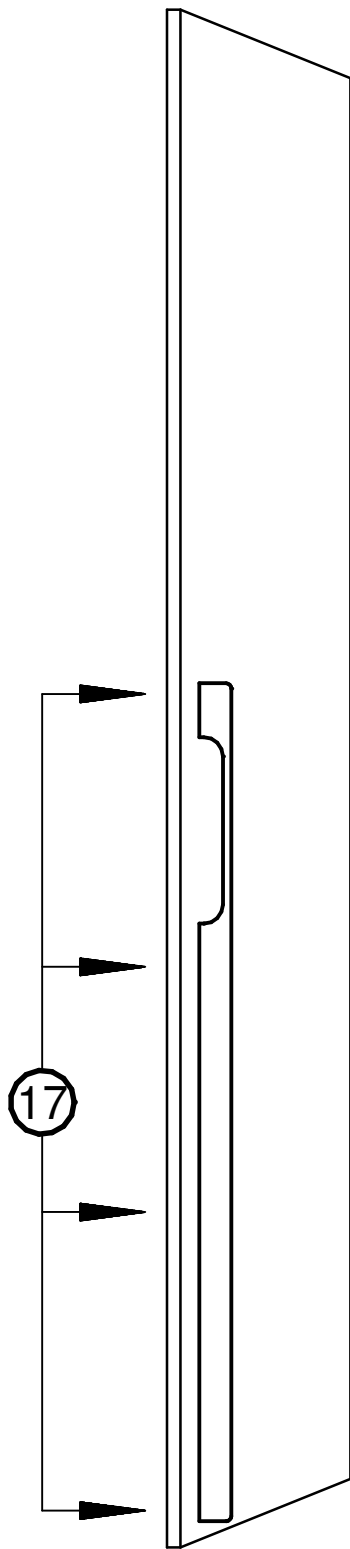



15.

