

T.-Nr. 731.8551

Index : 0

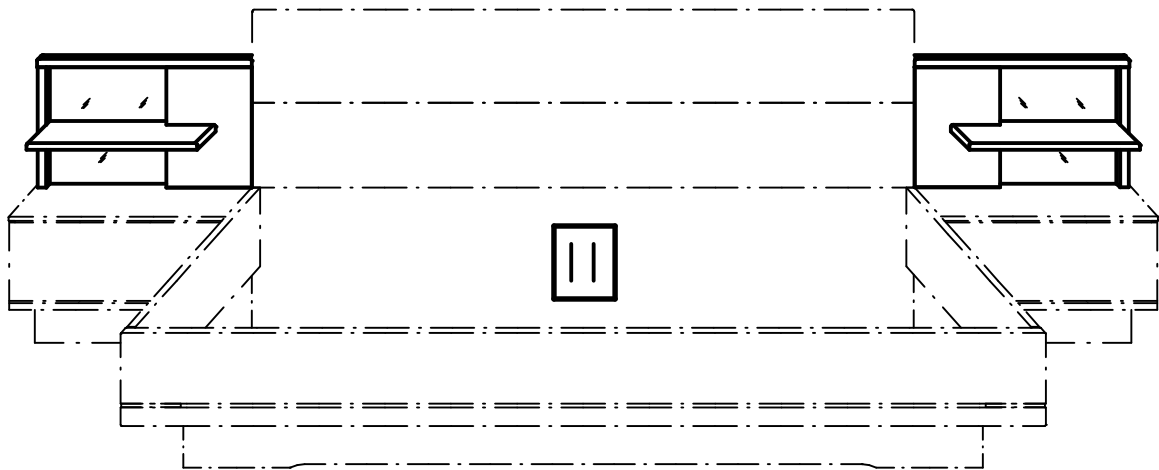

A

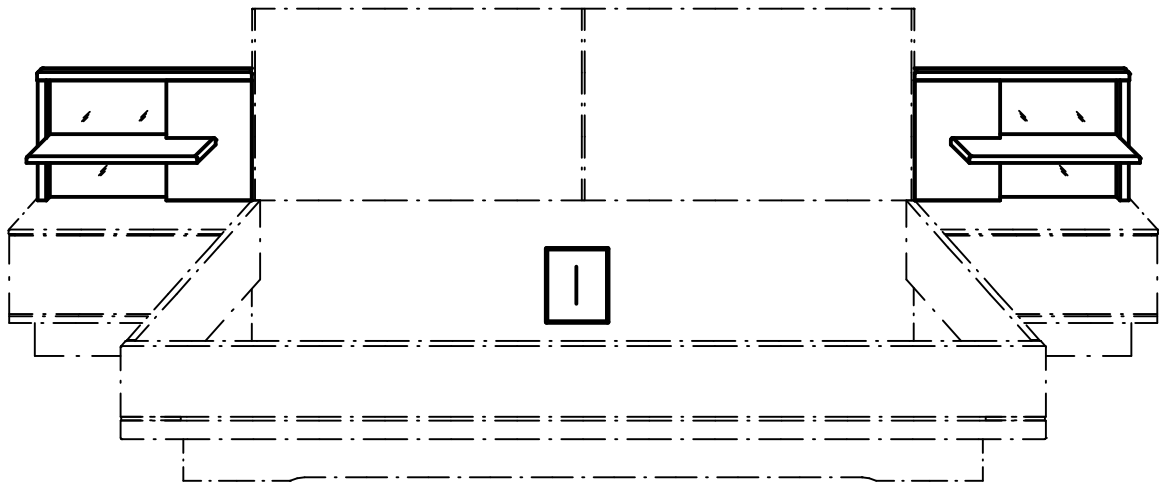
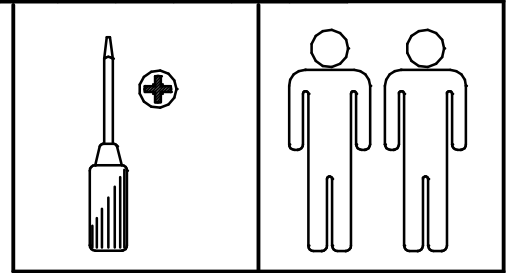
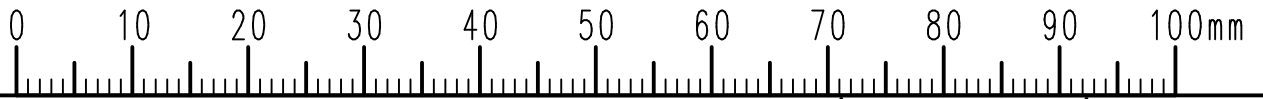
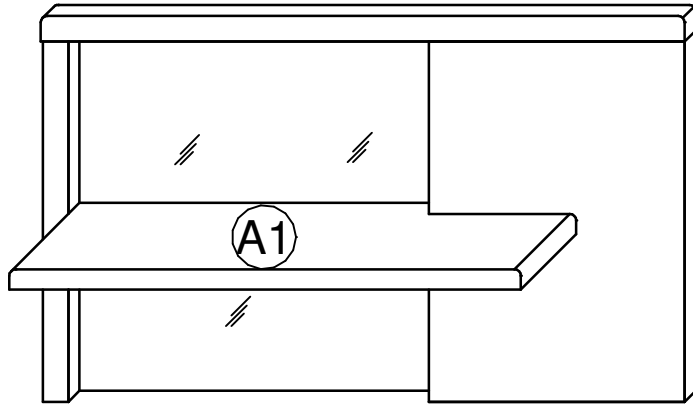

B

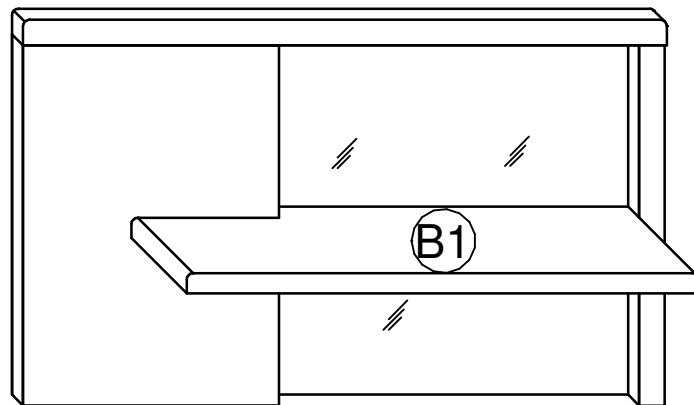

1.

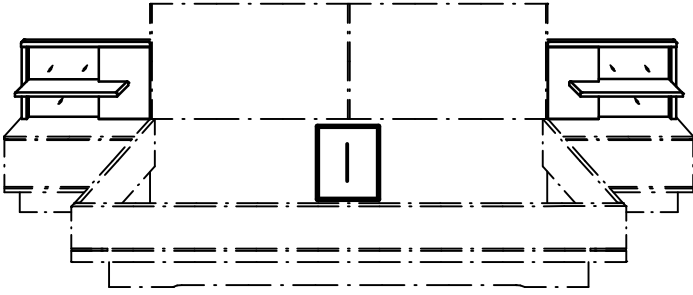

631.1535.000
4 x 40 mm

①

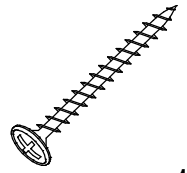

10 x

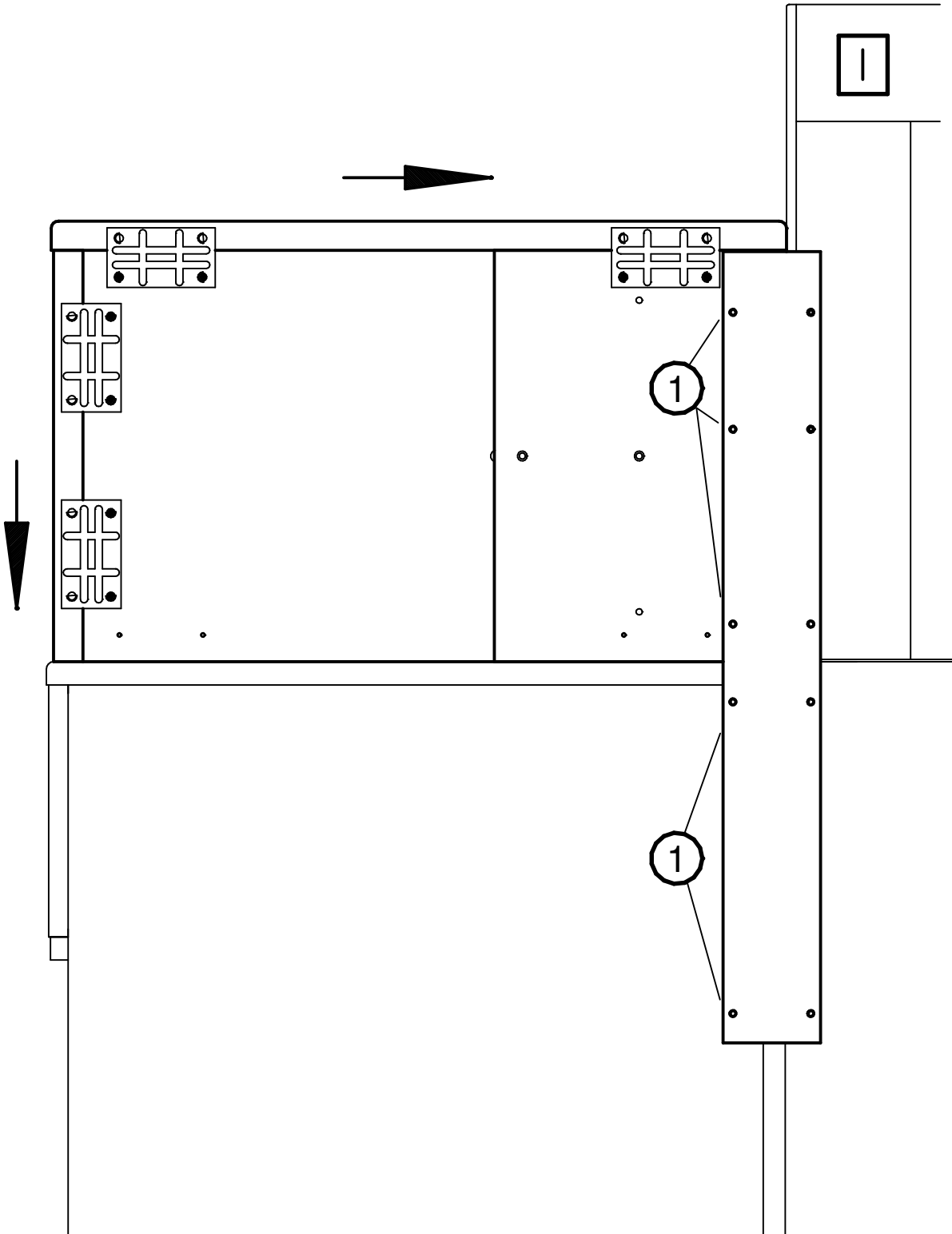

2.

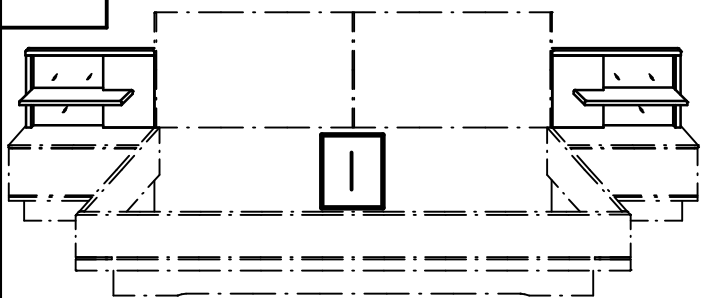

641.0253.000

632.0038.000

4 x 14 mm

②

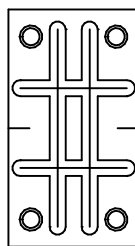

4 x

③



16 x

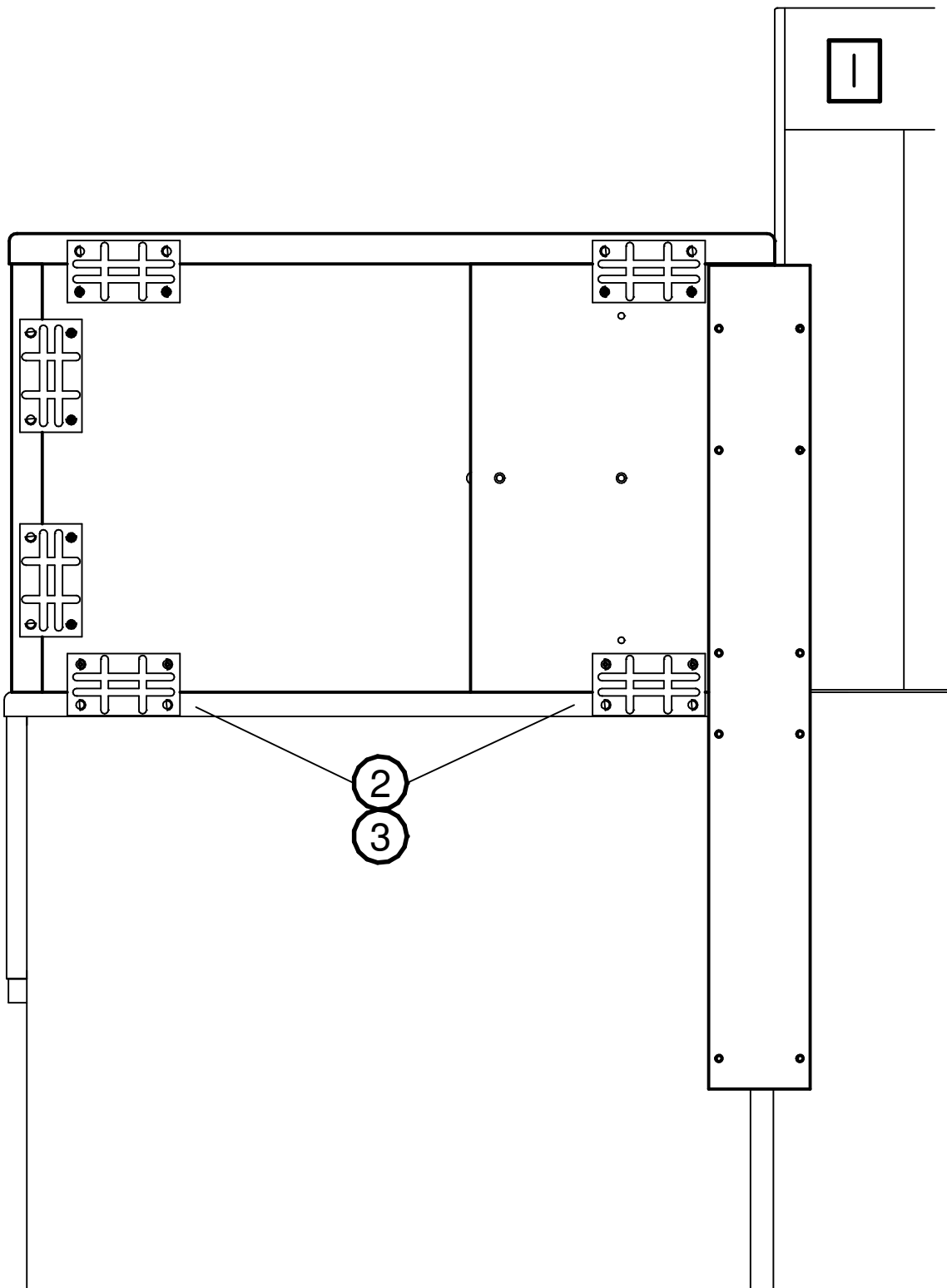

3.

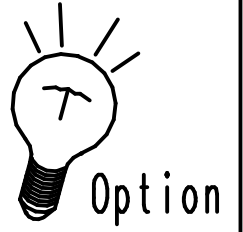
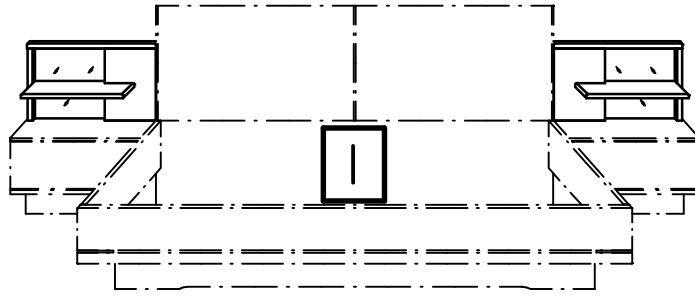

*Dieses Produkt enthält eine Lichtquelle der Energieeffizienzklasse <E>

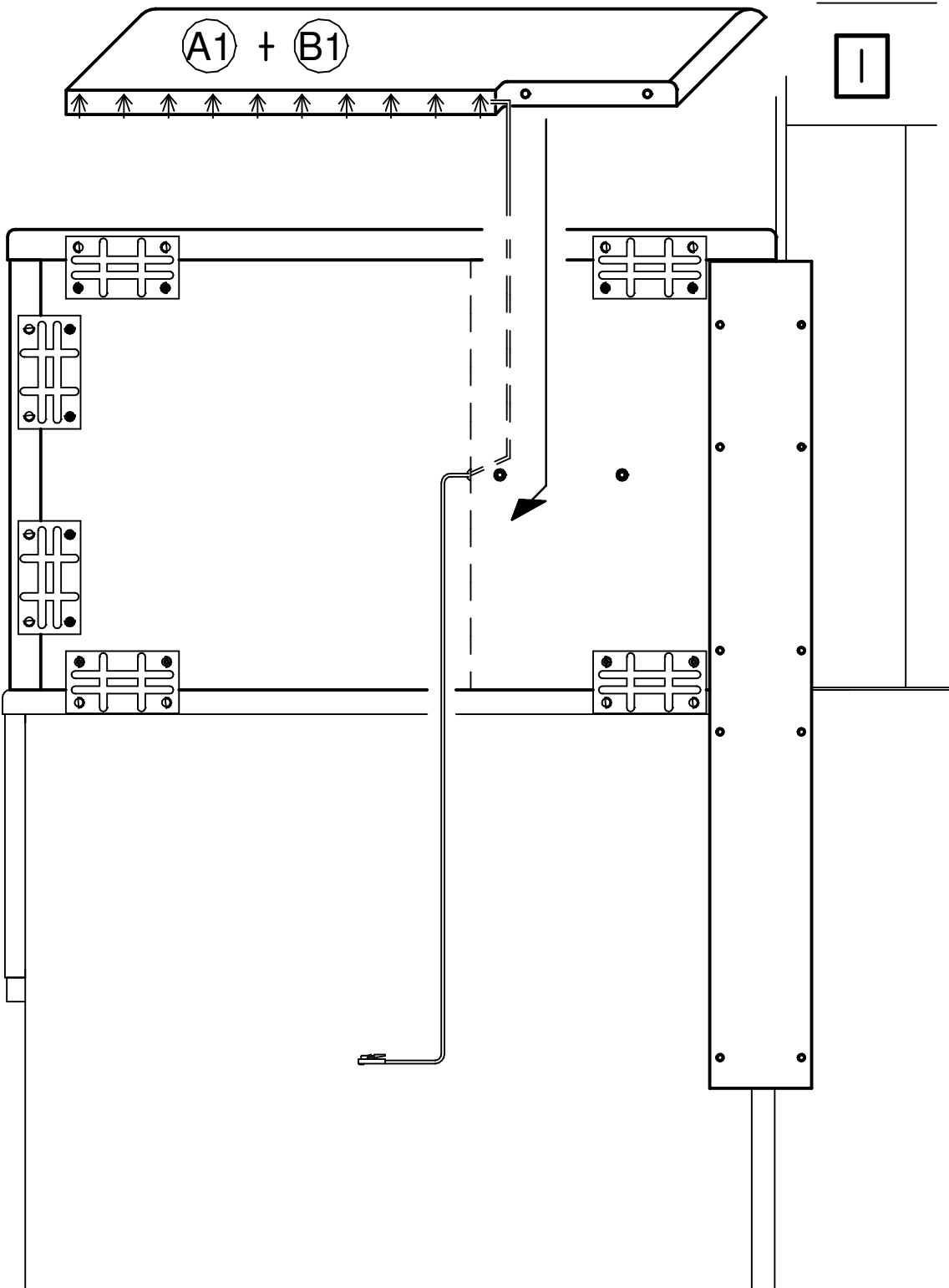

4.

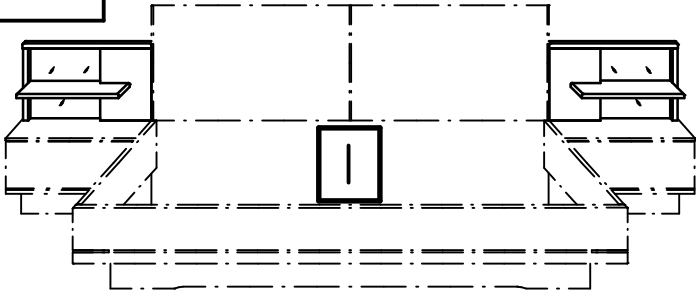

623.0105.000

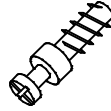

④

2 x

632.0564.000

5 x 100 mm

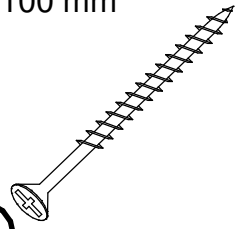

⑤

4 x

644.0049.000

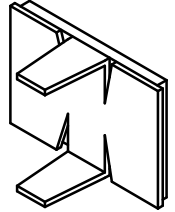

⑥

4 x

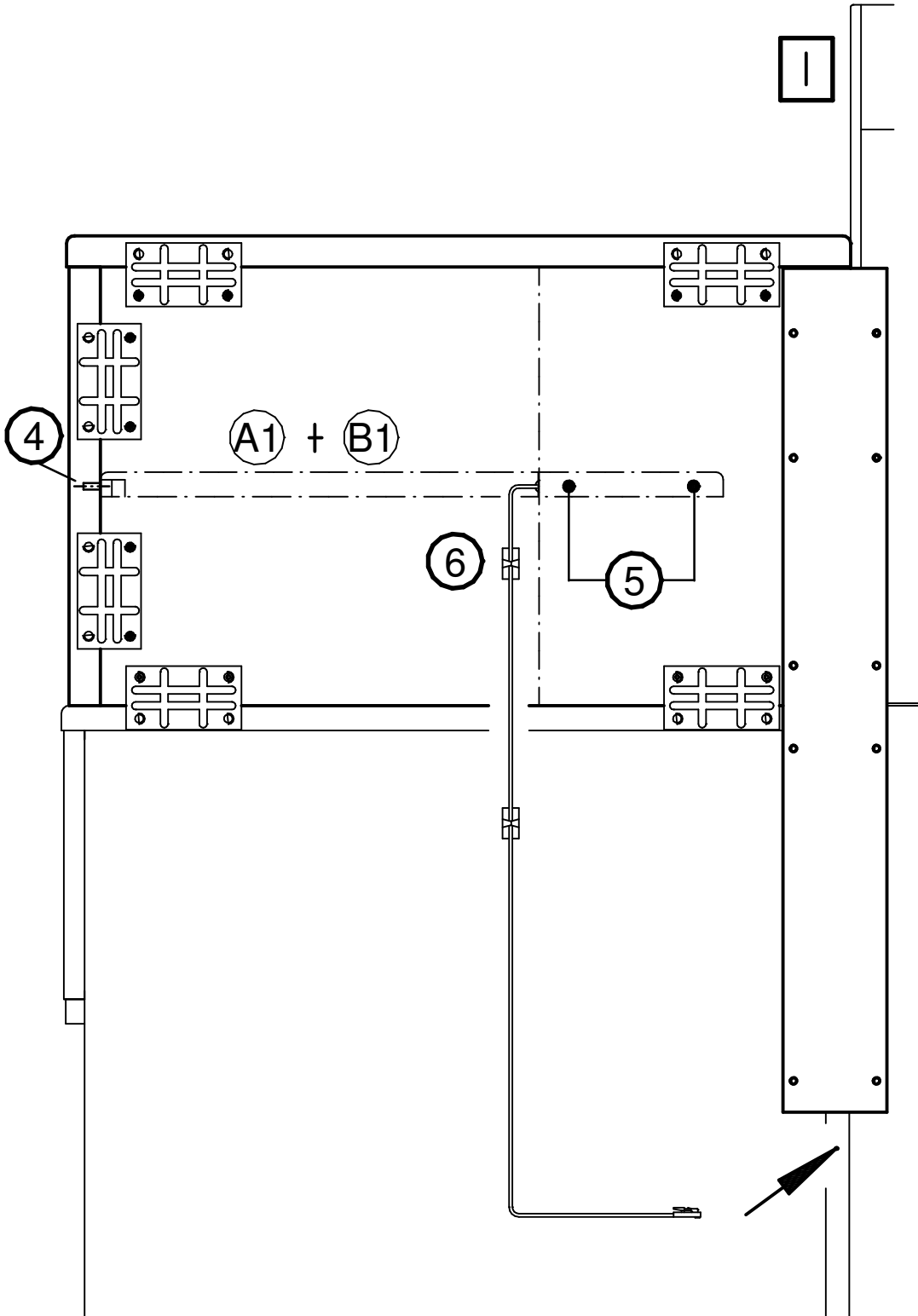

5.

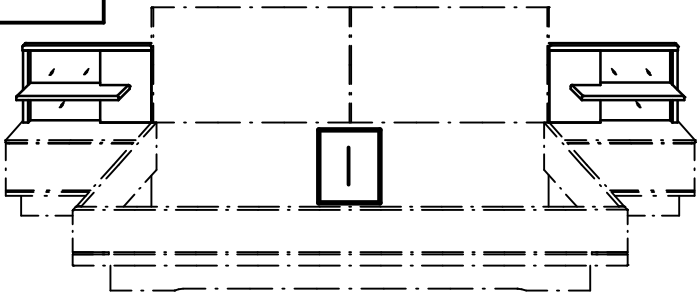

642.9030.000

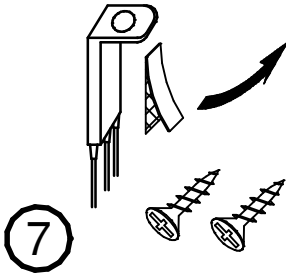

2 x

642.9028.000

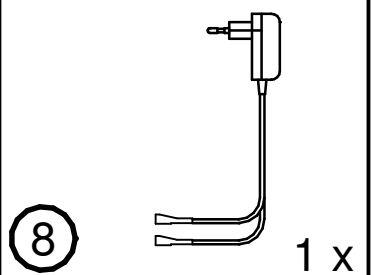

1 x

Option

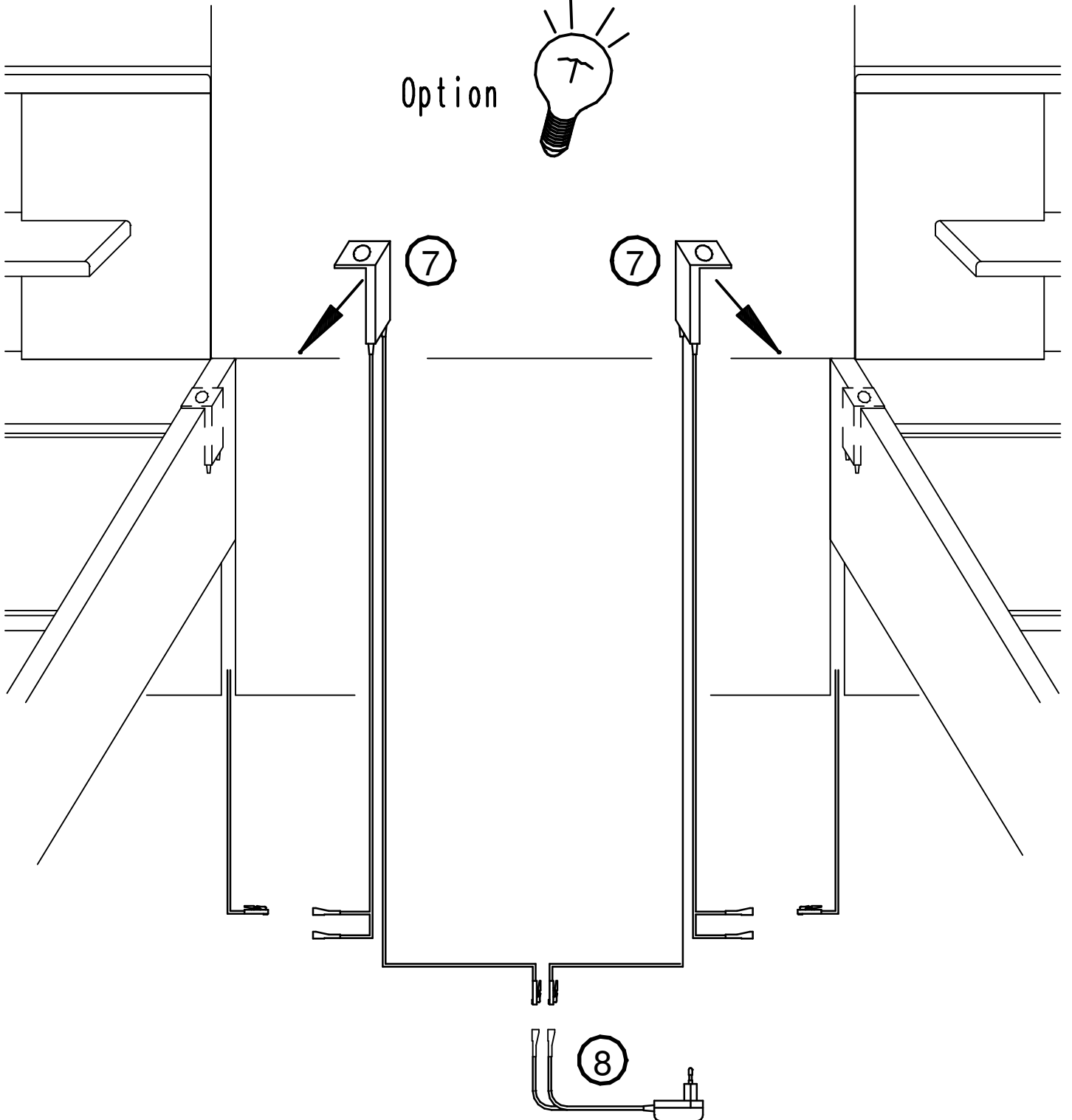

6.

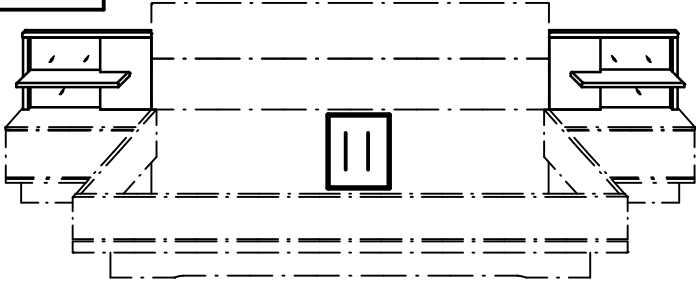

641.0253.000

632.0038.000

4 x 14 mm

9

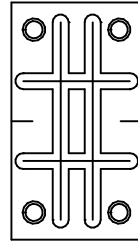

6 x

10



24 x

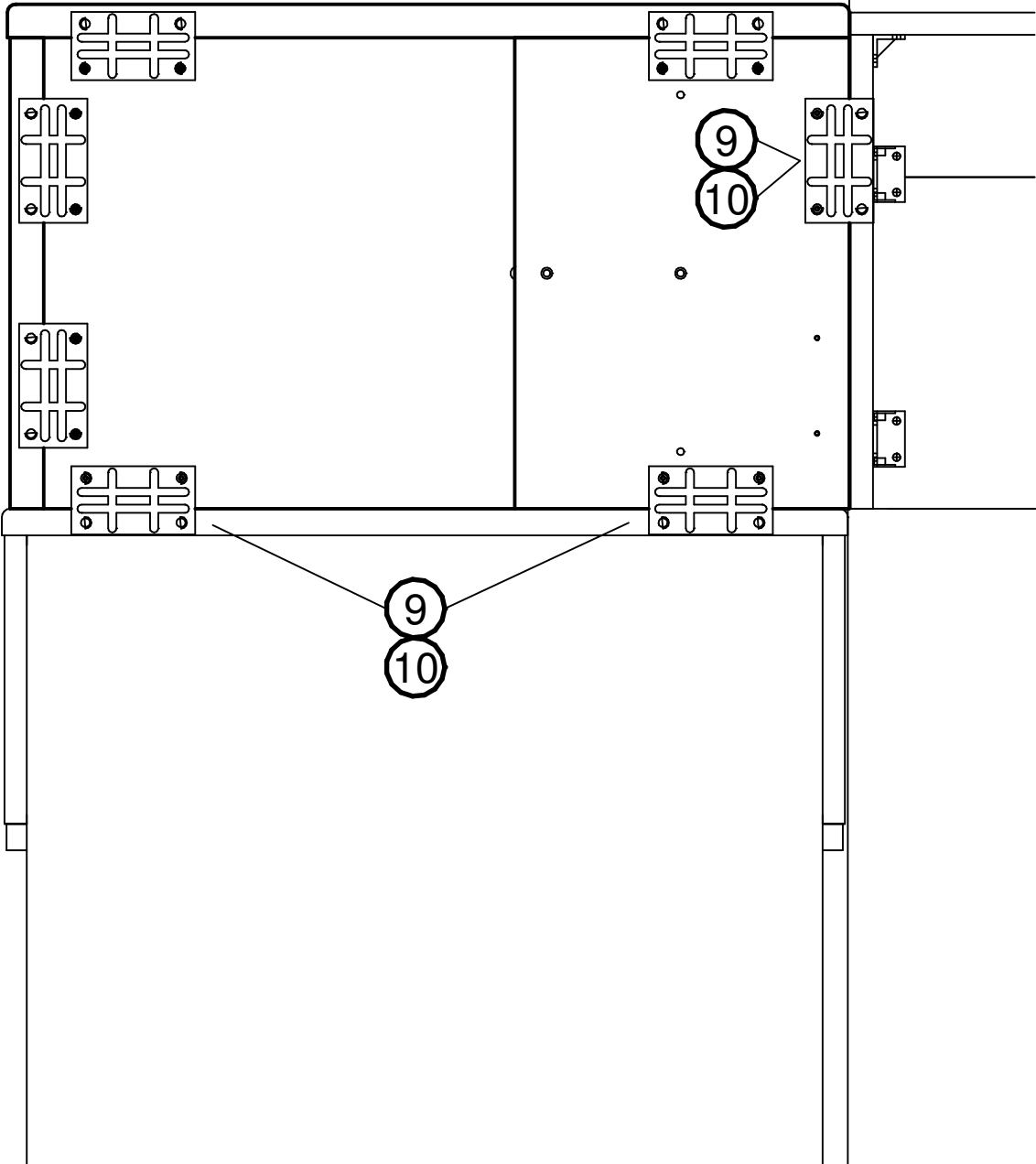

7.

Option

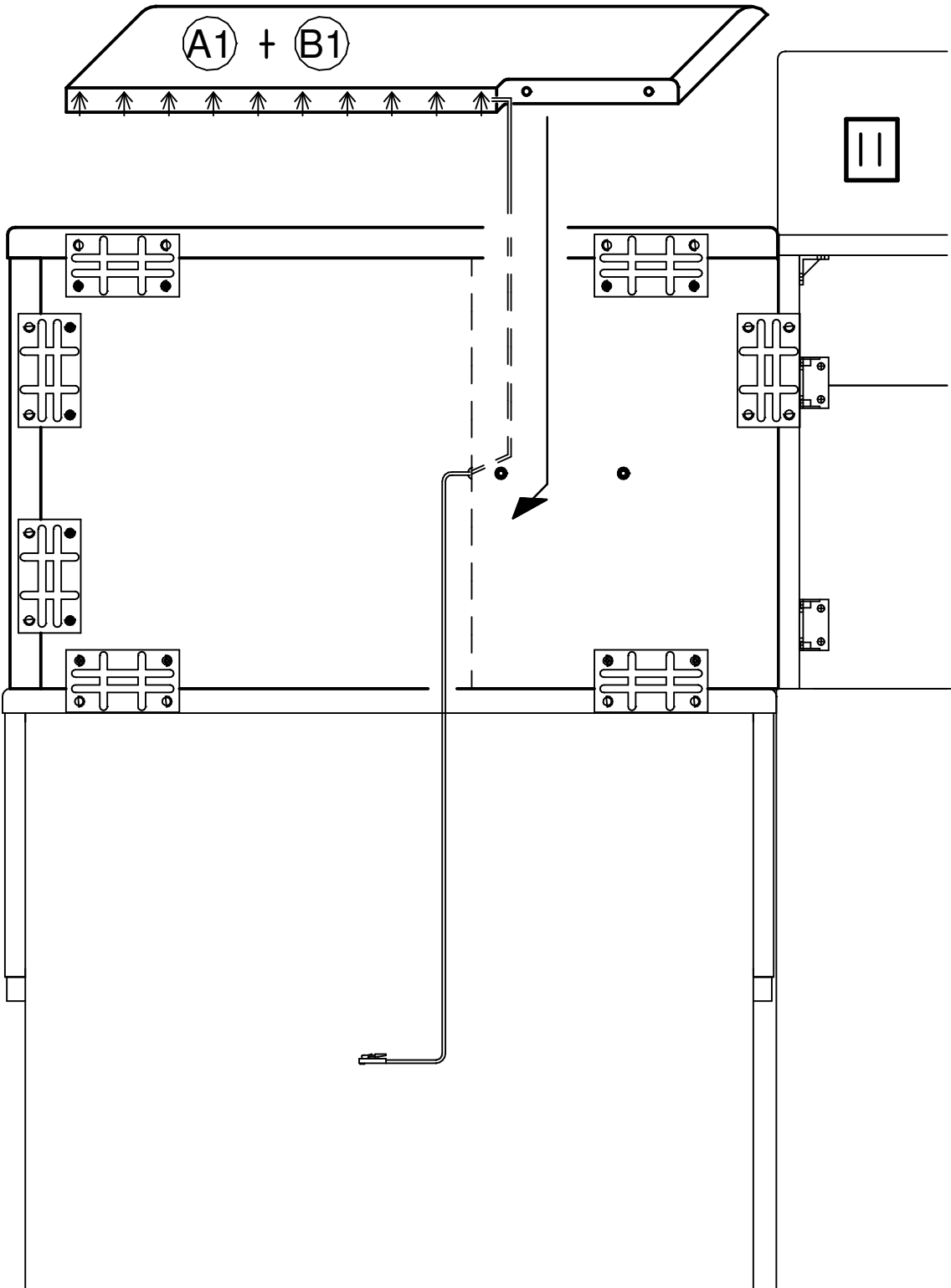
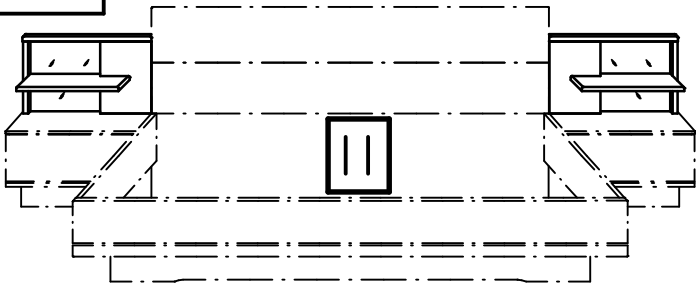

8.

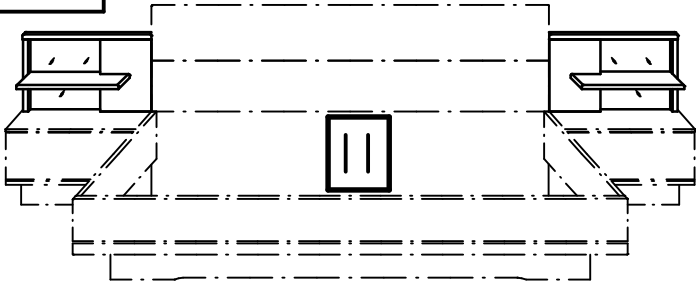

623.0105.000

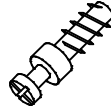

11

2 x

632.0564.000

5 x 100 mm

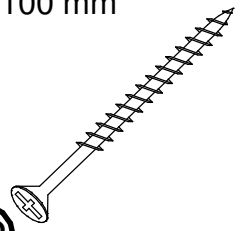

12

4 x

644.0049.000

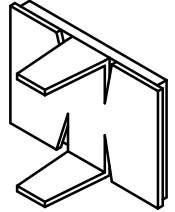

13

4 x

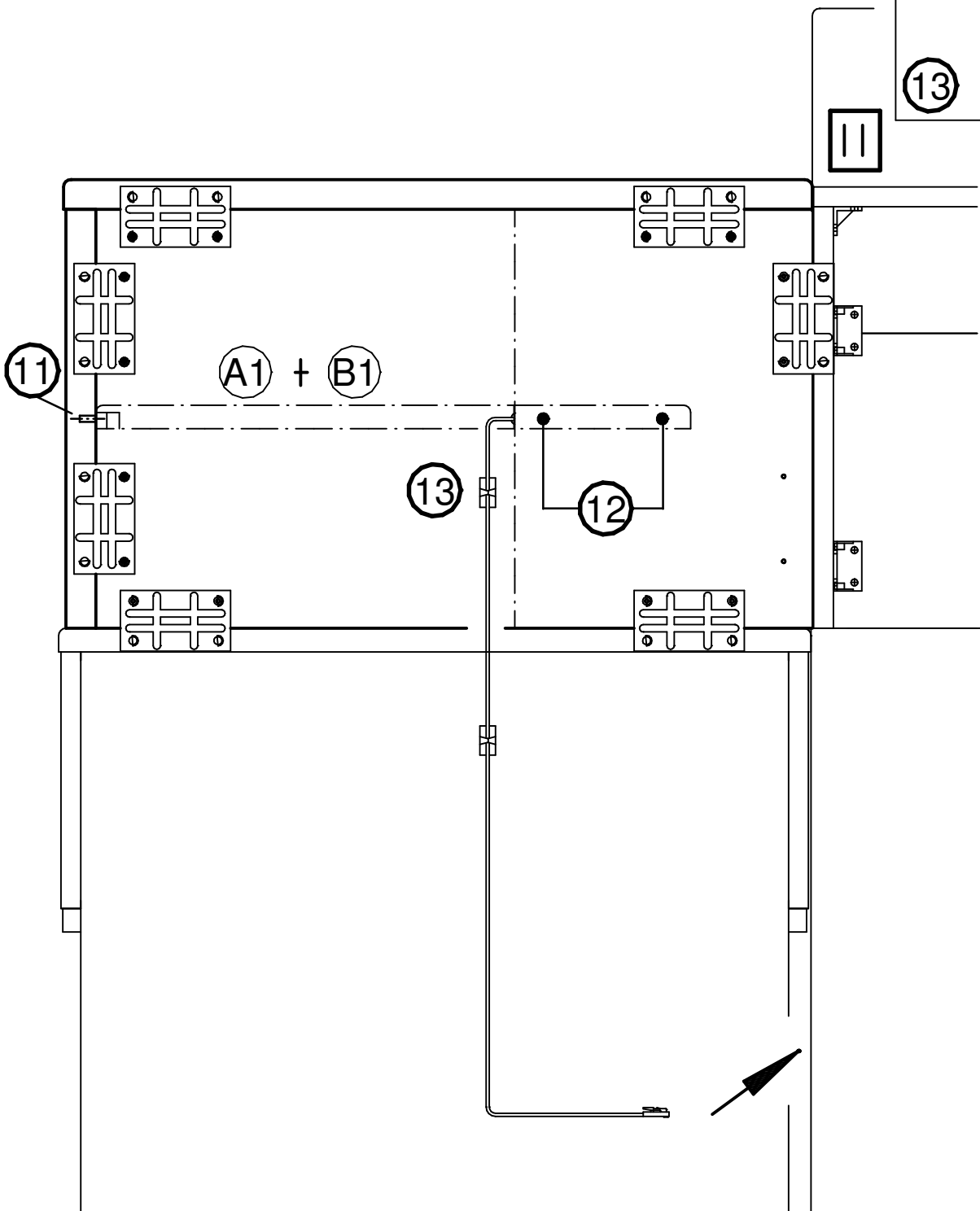

9.

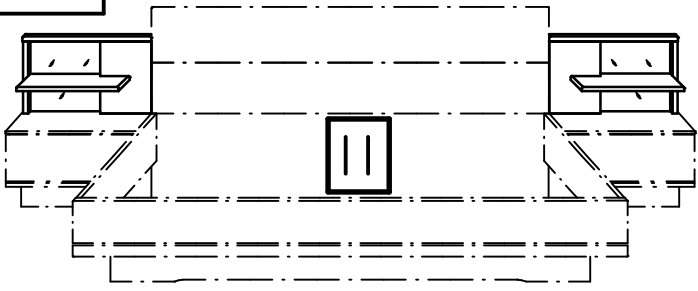

642.9030.000

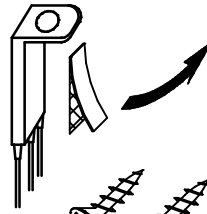

14

2 x

642.9028.000

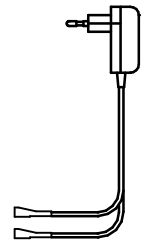

15

1 x

Option

