

*Dieses Produkt enthält eine Lichtquelle der Energieeffizienzklasse <G>

OPTION

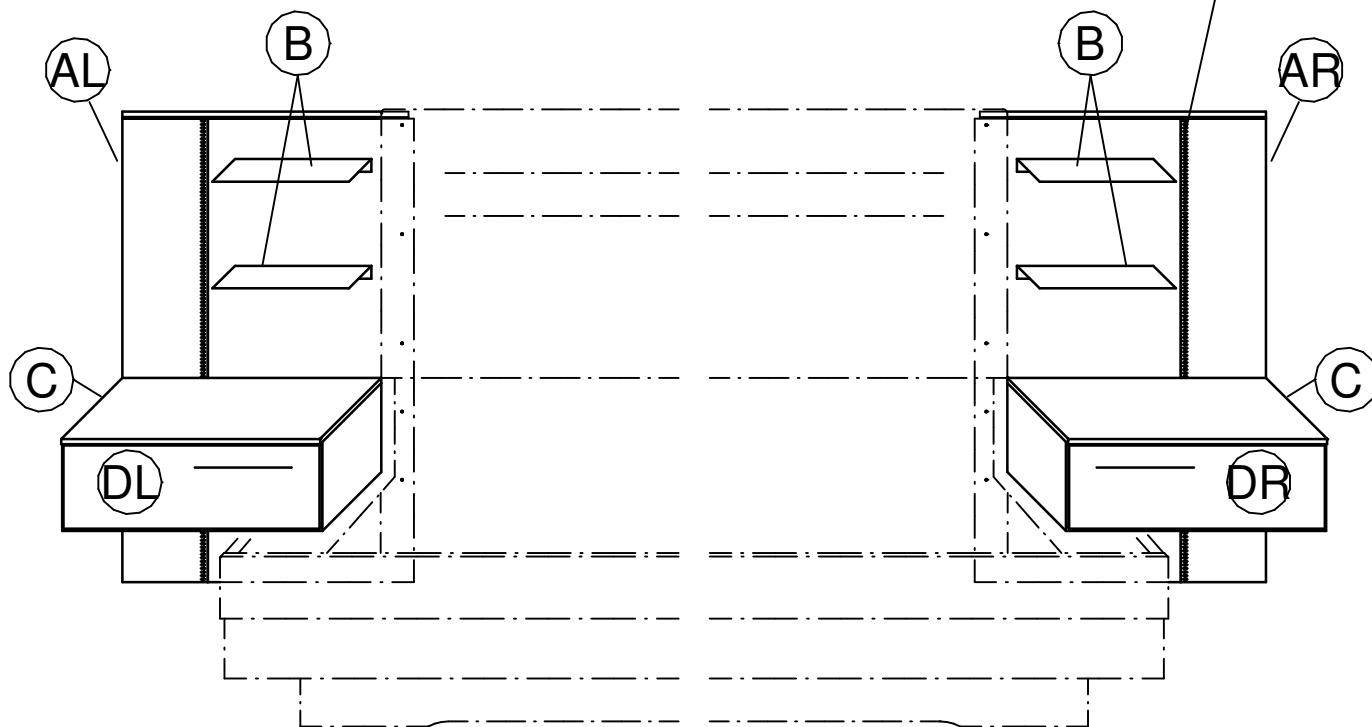

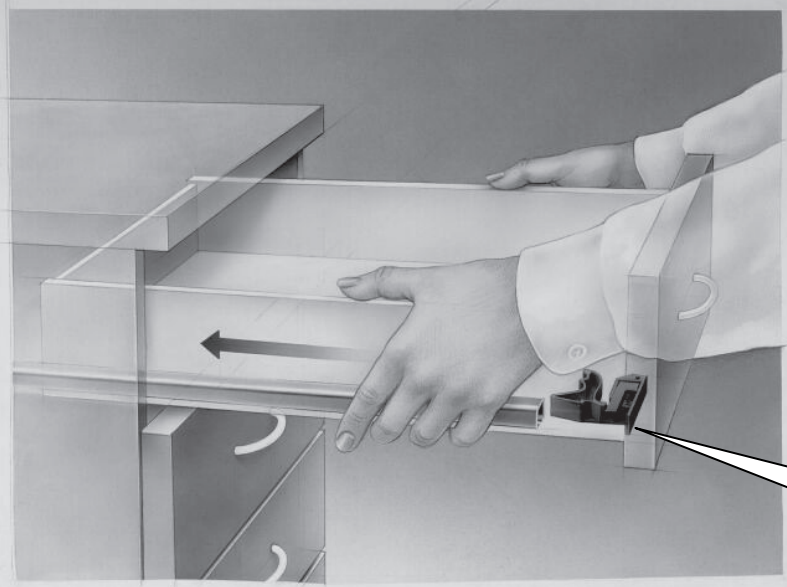

click

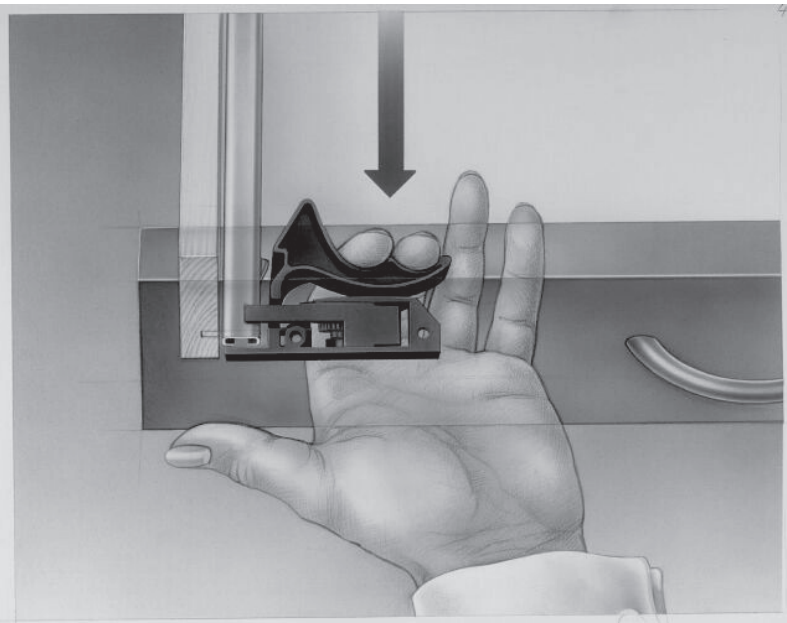
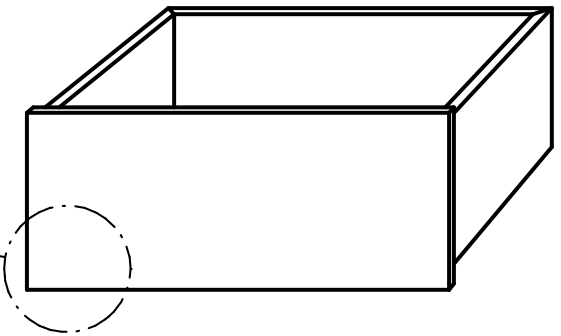
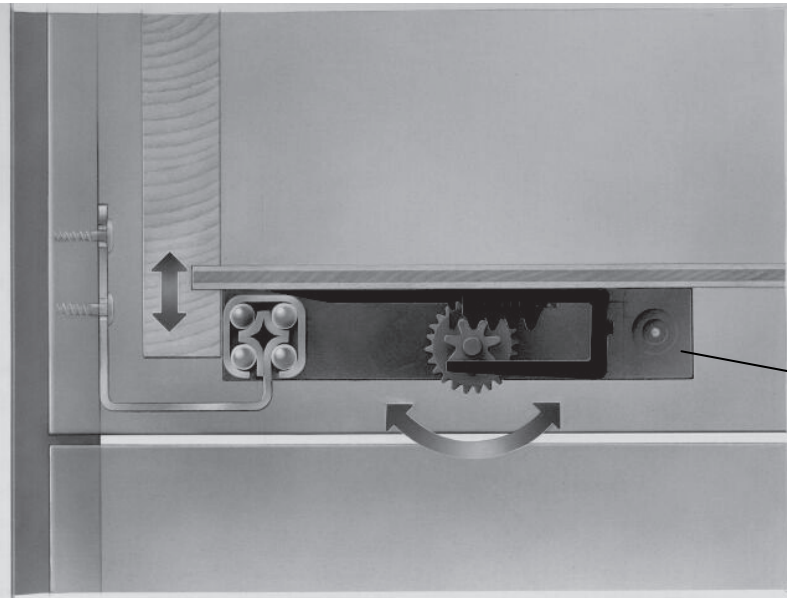

1.

631.1140.000
4 x 45 mm

①

4 x

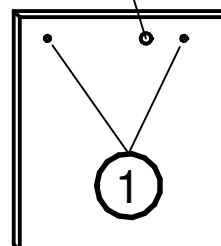
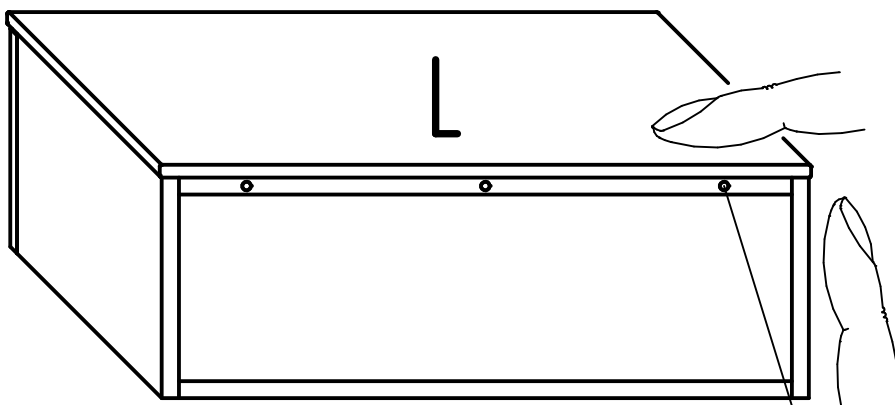
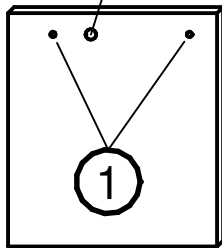
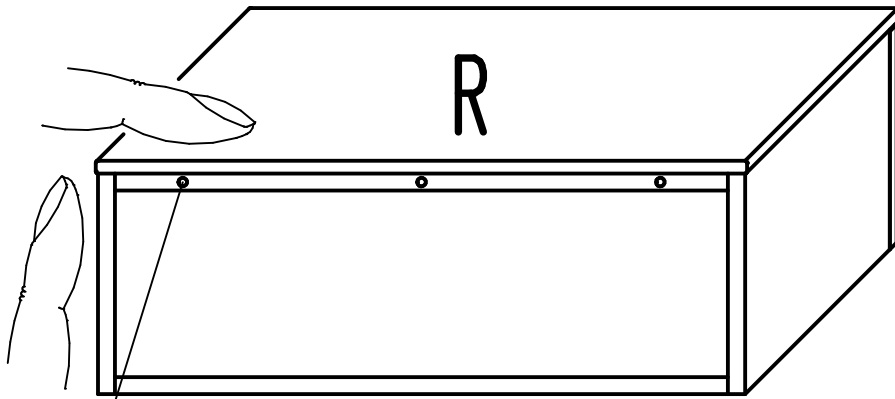
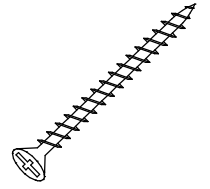

2.

631.1202.000
7 x 70 mm

②

6 x

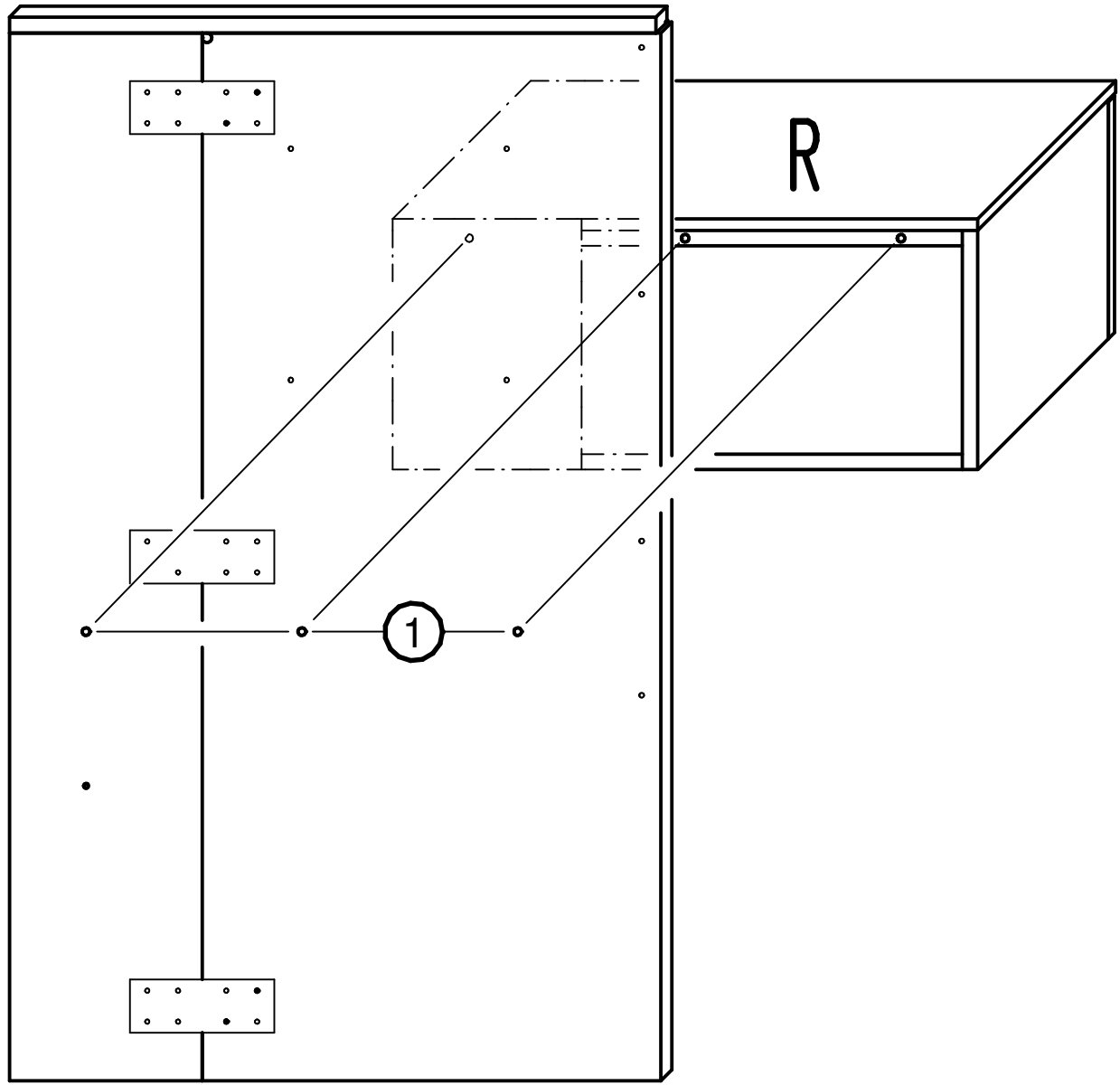

3.

631.1530.000
4 x 30 mm

632.0031.000

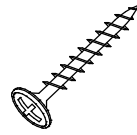

3

2 x

4

4 x

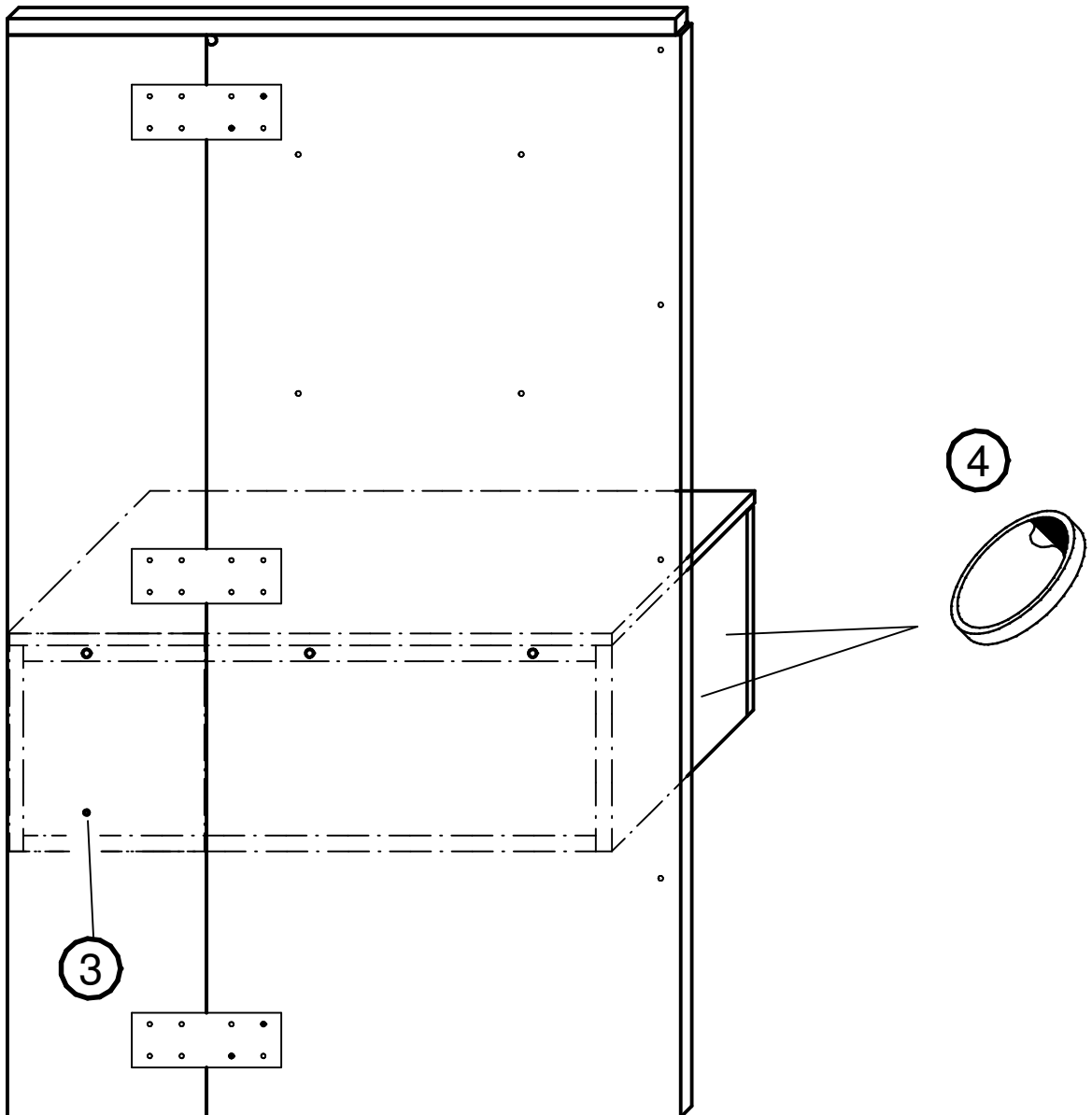

4.

631.1140.000
4 x 45 mm

5

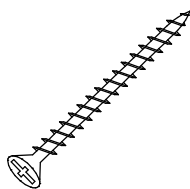

10 x

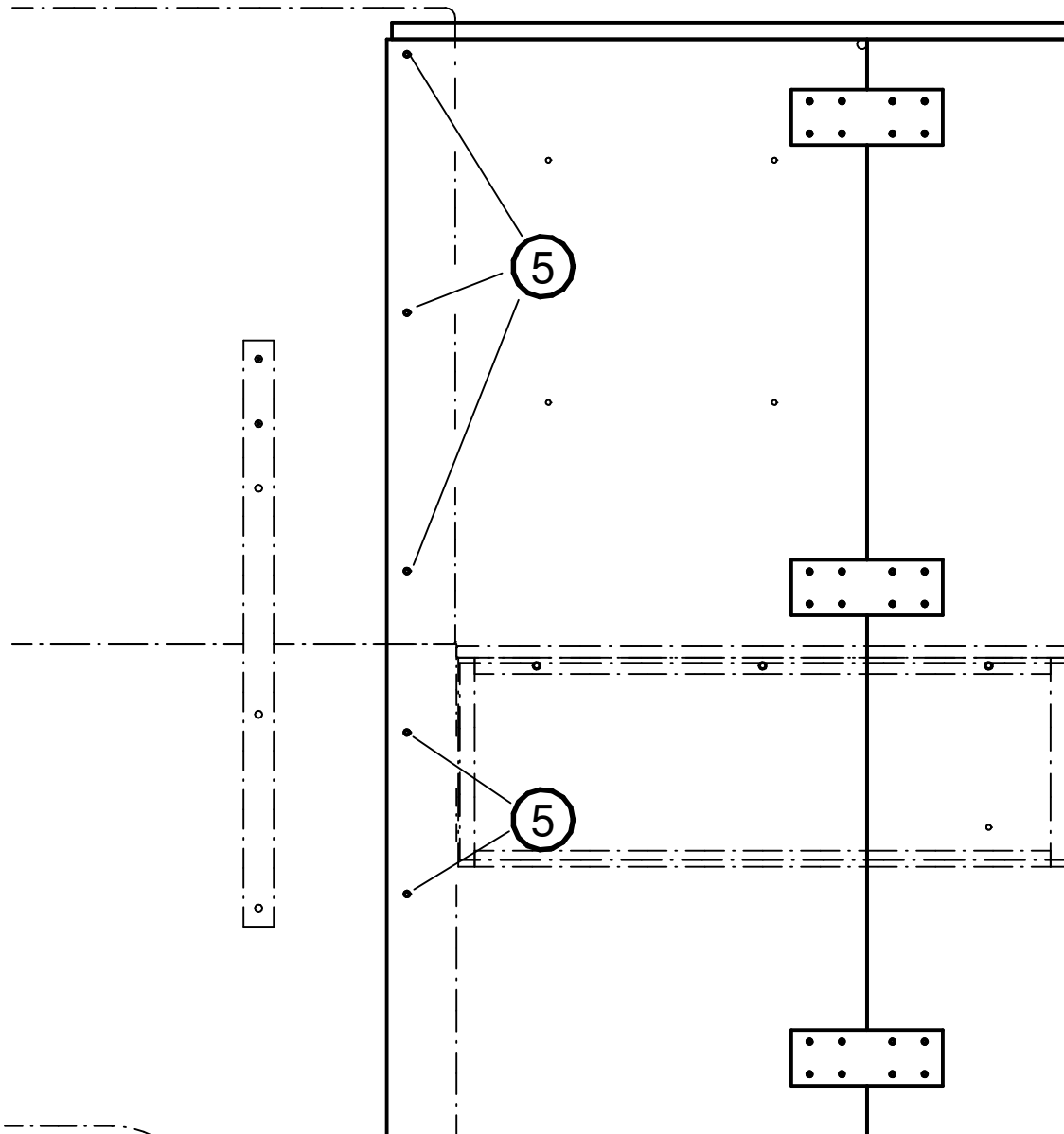

5.

631.1063.000
4 x 35 mm

⑥

4 x

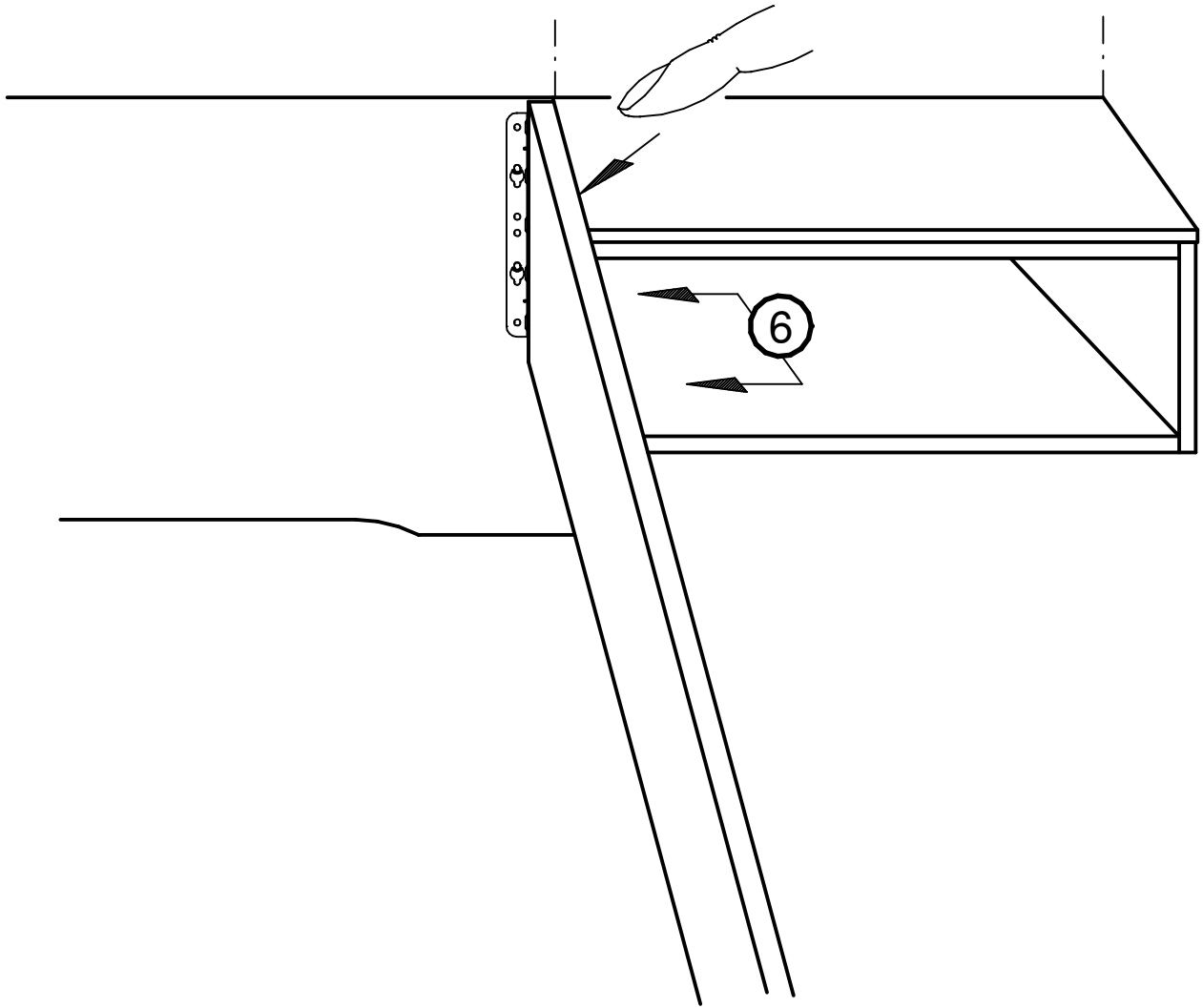
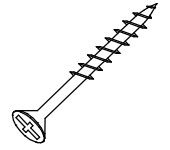

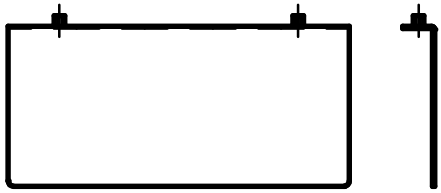

632.0581.000
M 4 x 40 mm

631.1704.000

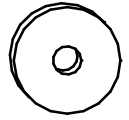
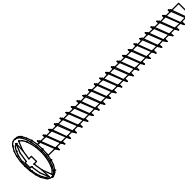

(B)

4 x

(7)

8 x

(8)

8 x

6.

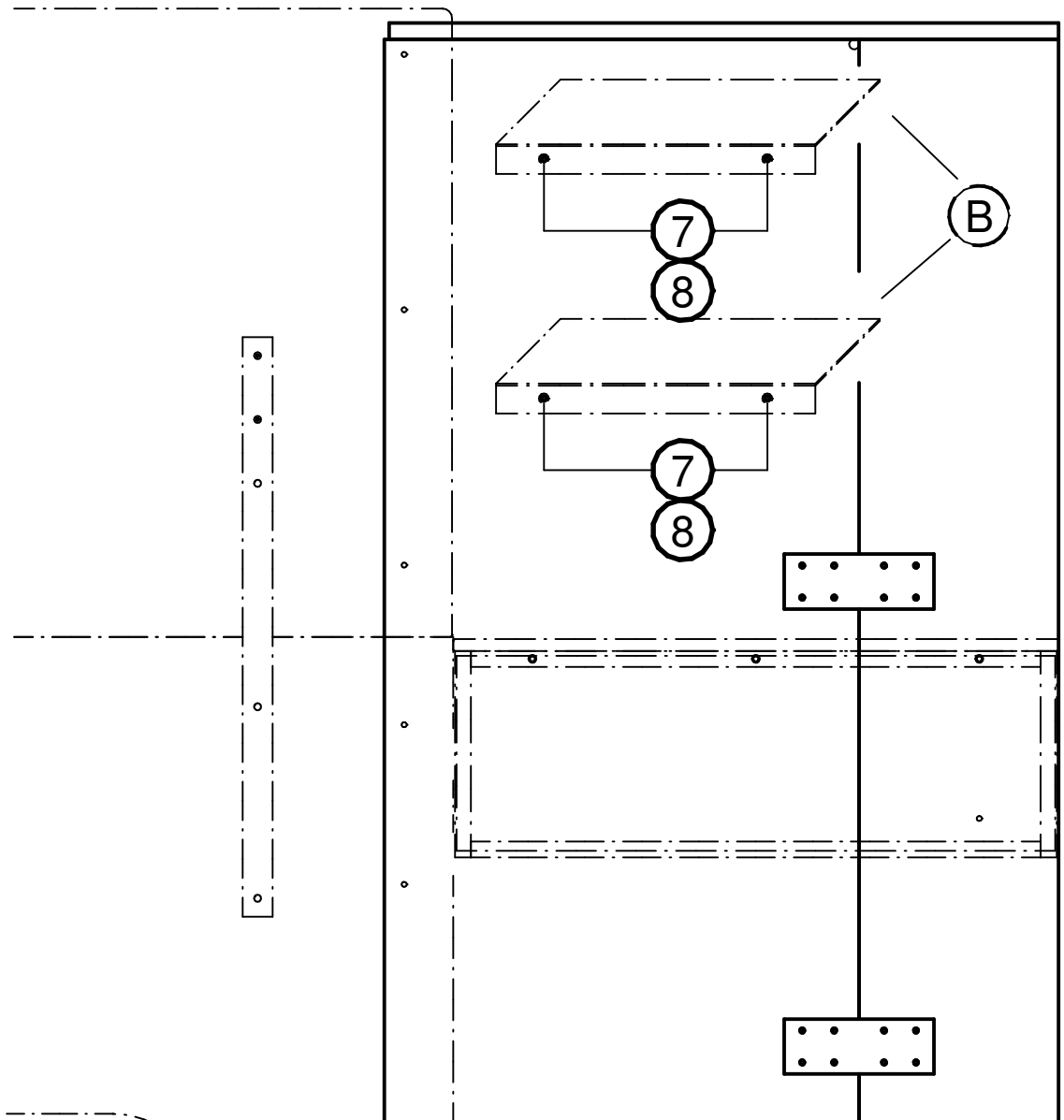
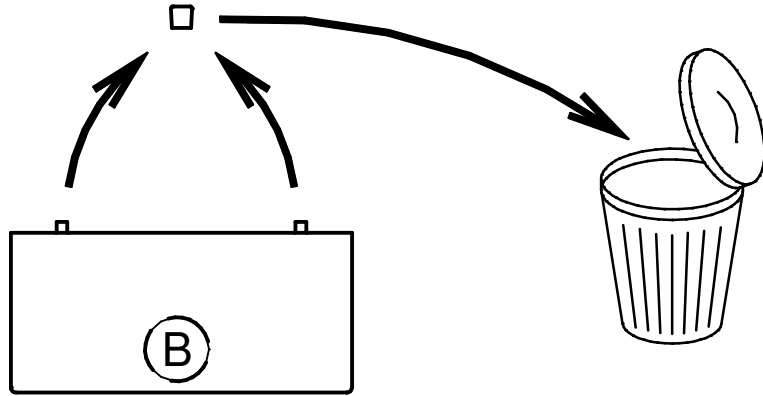

OPTION

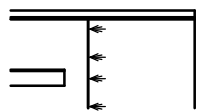

644.0049.000

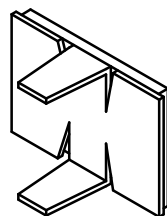

9

6 x

631.1460.000

4 x 15 mm



10

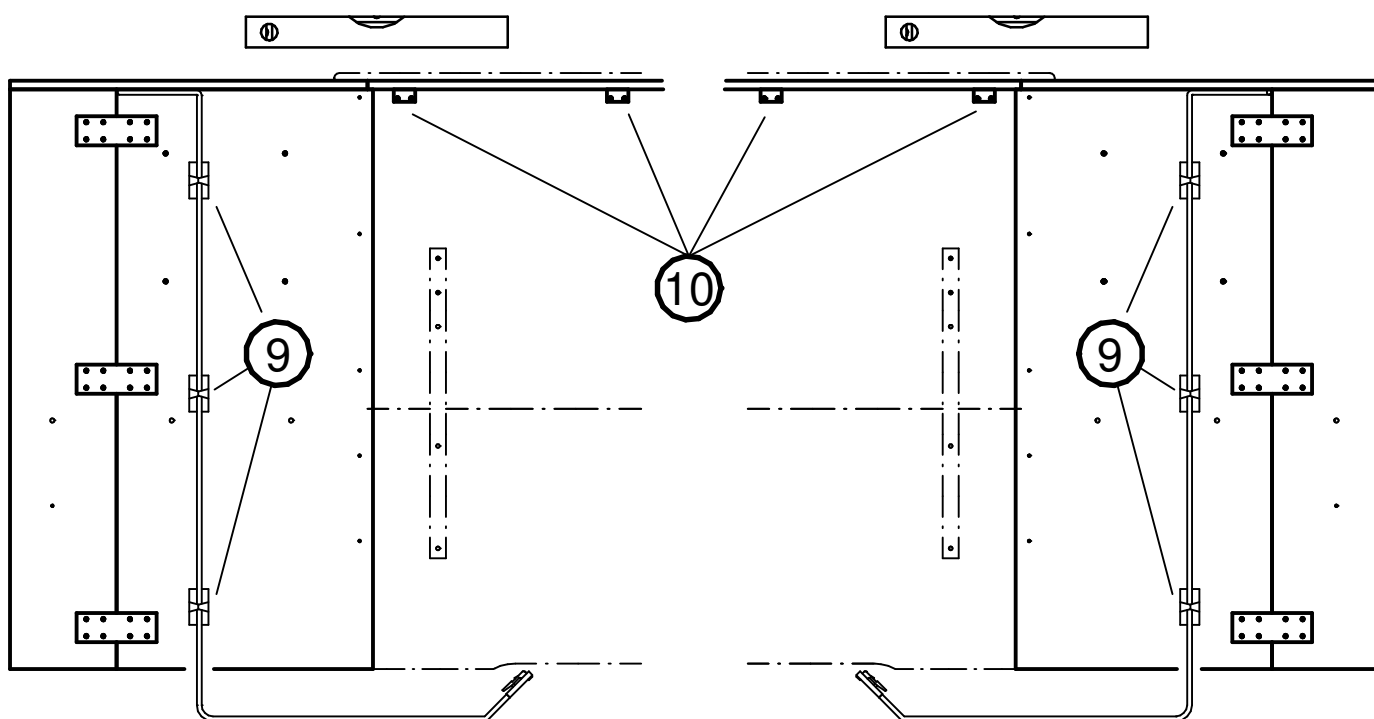
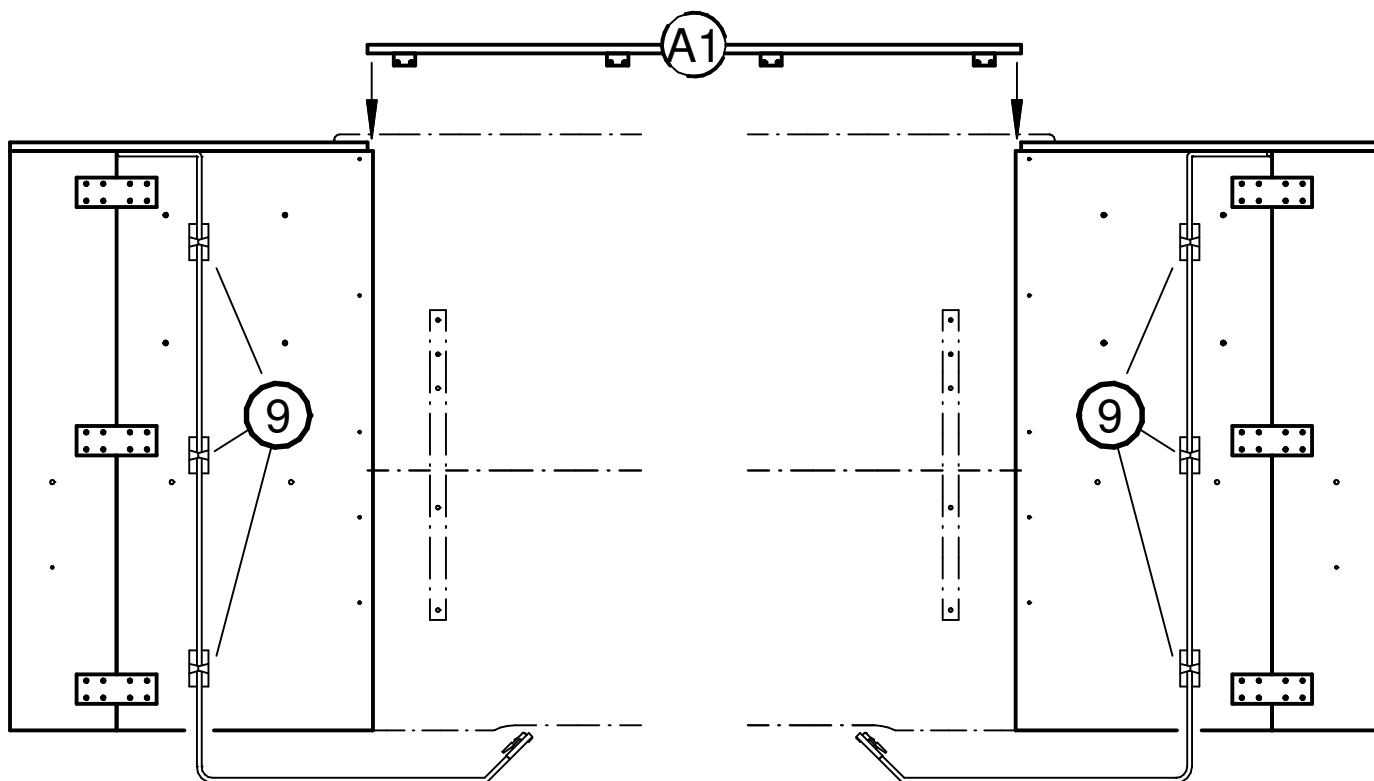

OPTION

644.0049.000

644.0331.000

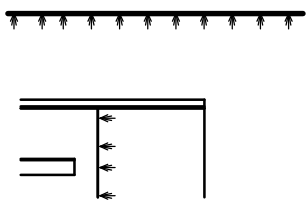

9

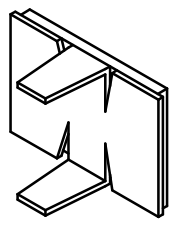

4 x

11

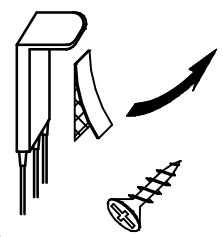

2 x

12

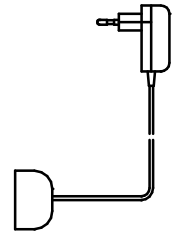

1 x

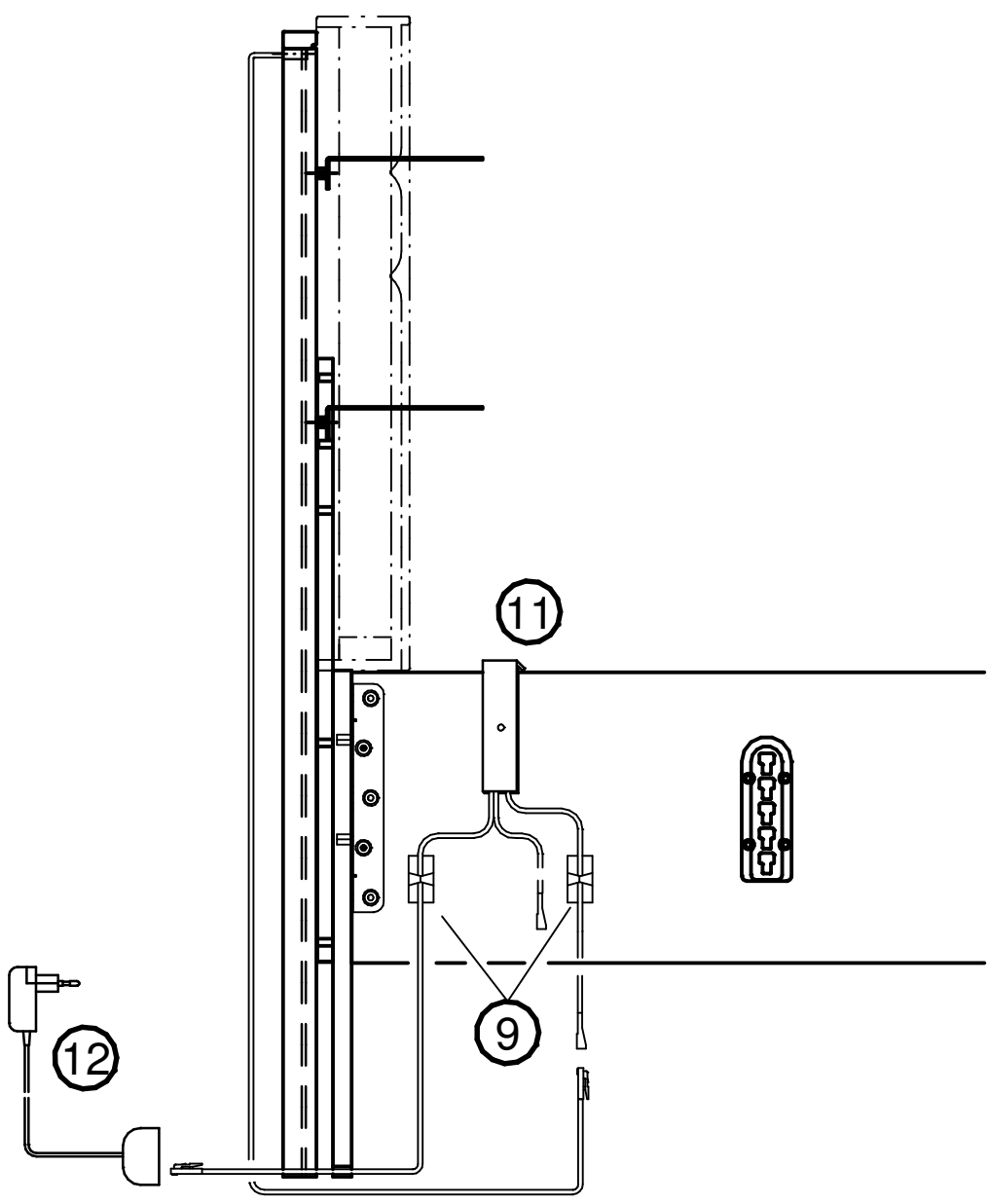

OPTION

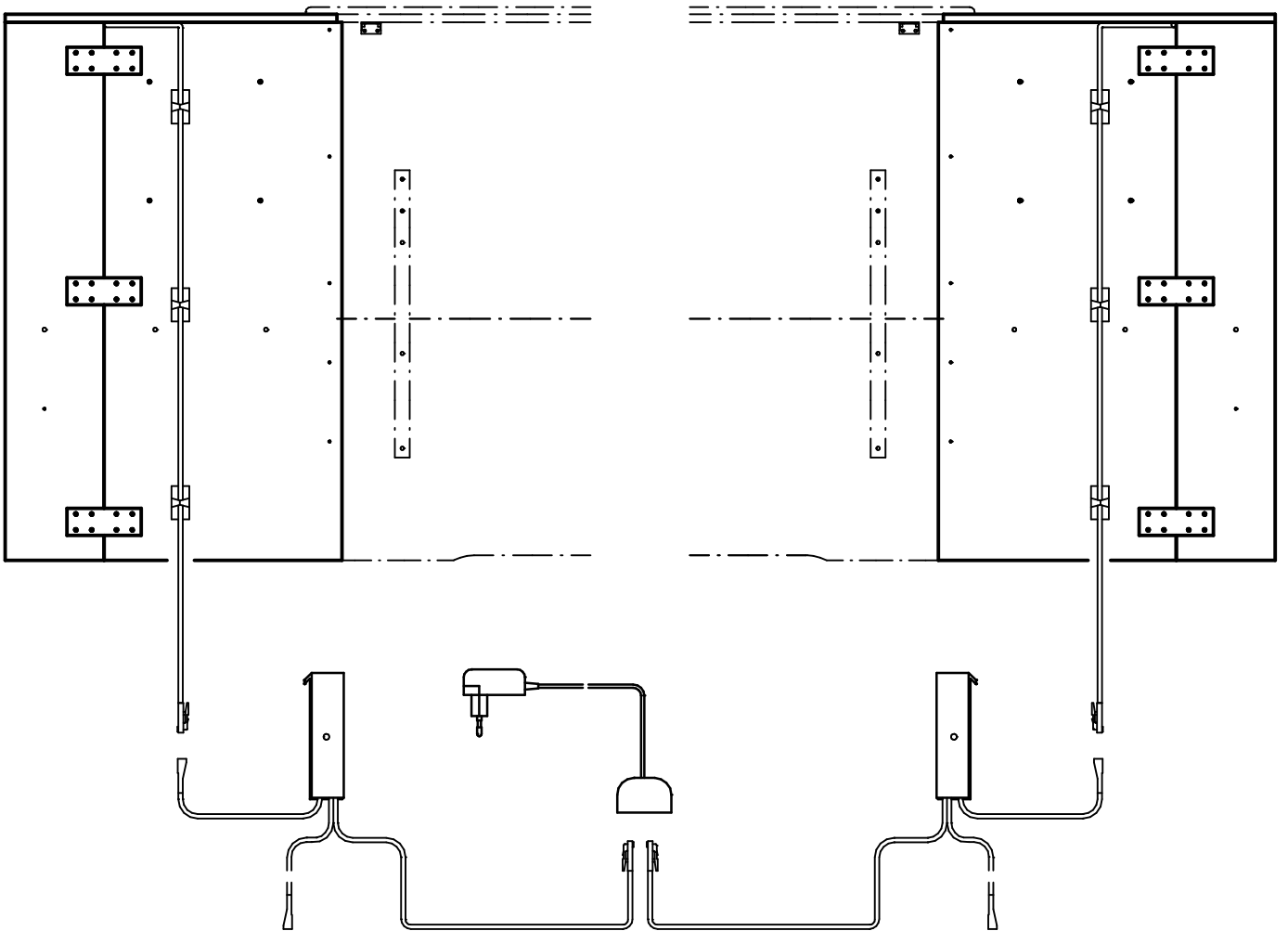
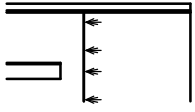

7.

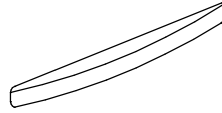

13

2 x

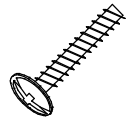

14

4 x

