

*Dieses Produkt enthält eine Lichtquelle der Energieeffizienzklasse <G>

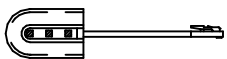

C1

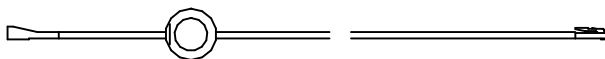

C2

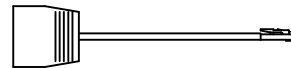

C3

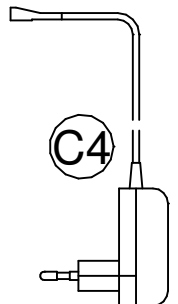

C4



1.

624.0092.000

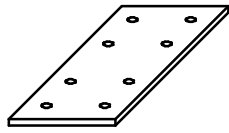

①

4 x

631.1460.000

4 x 15 mm



②

32 x

631.1201.000

7 x 50 mm

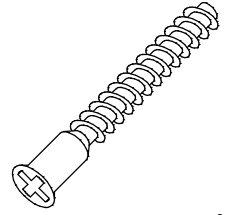

③

4 x

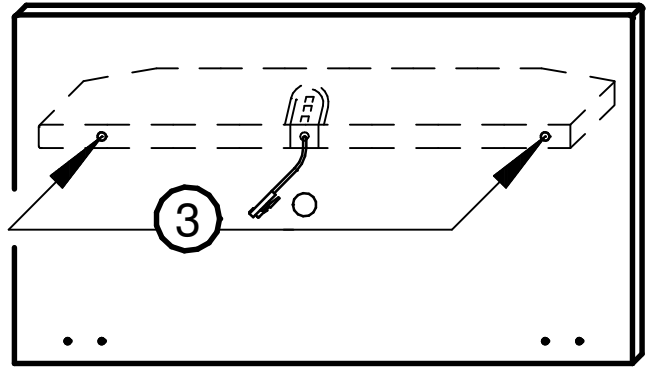
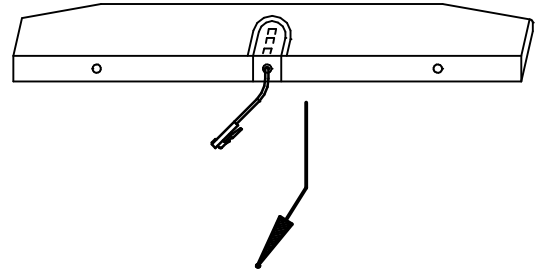
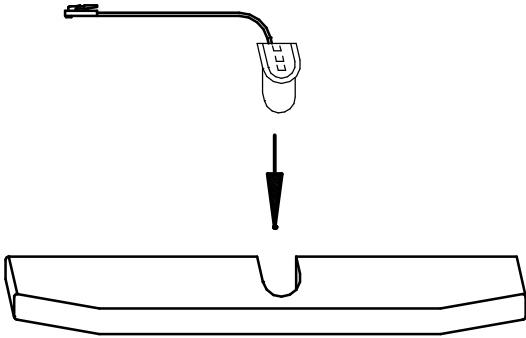

③

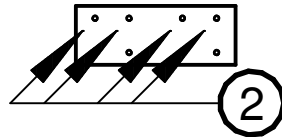

②

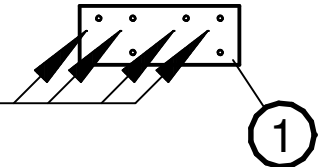

①

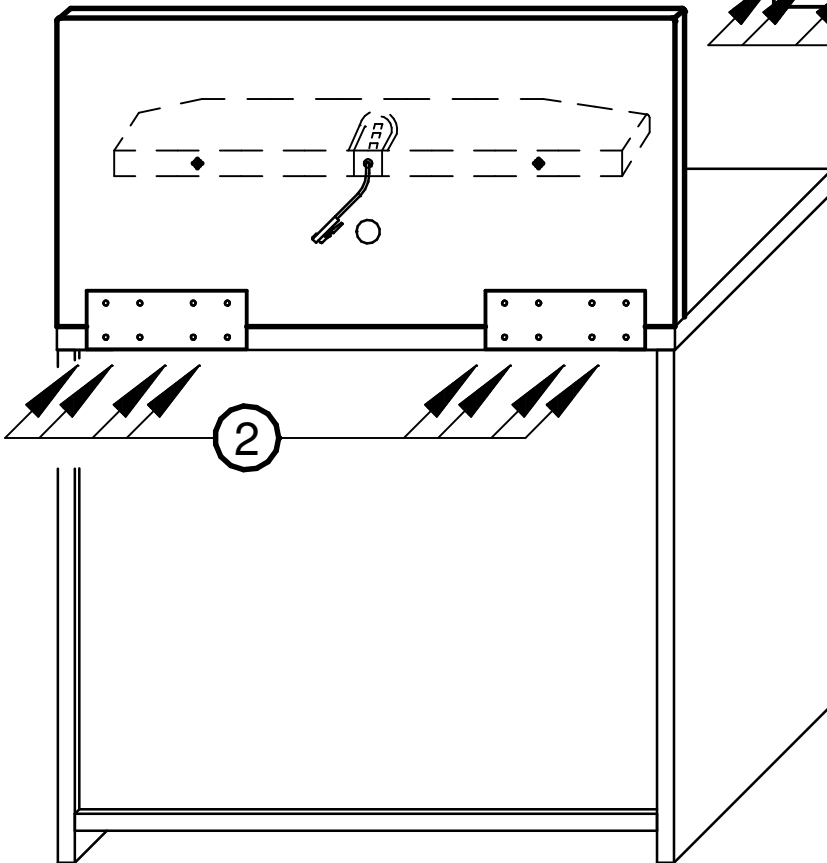

②

2.

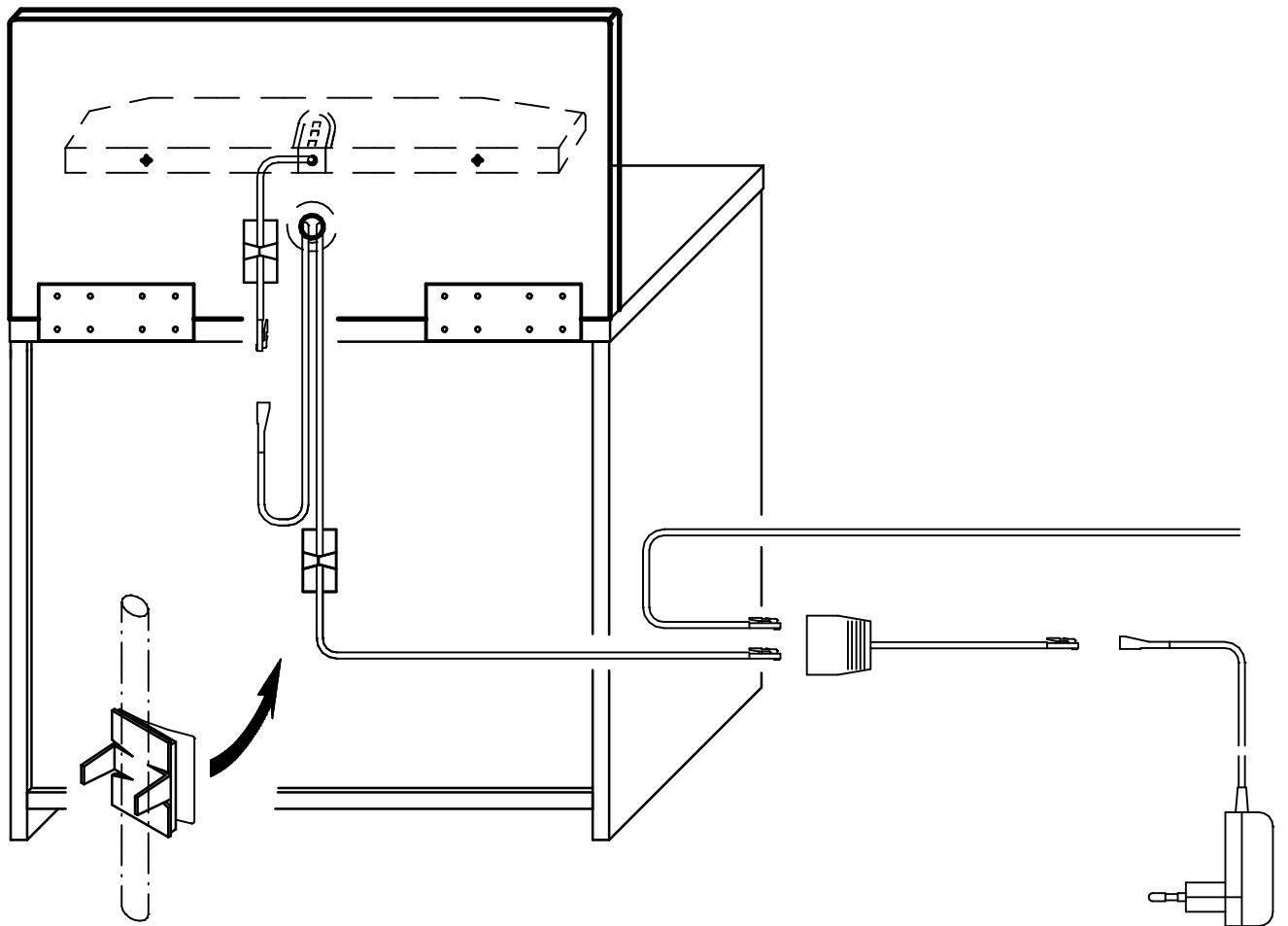
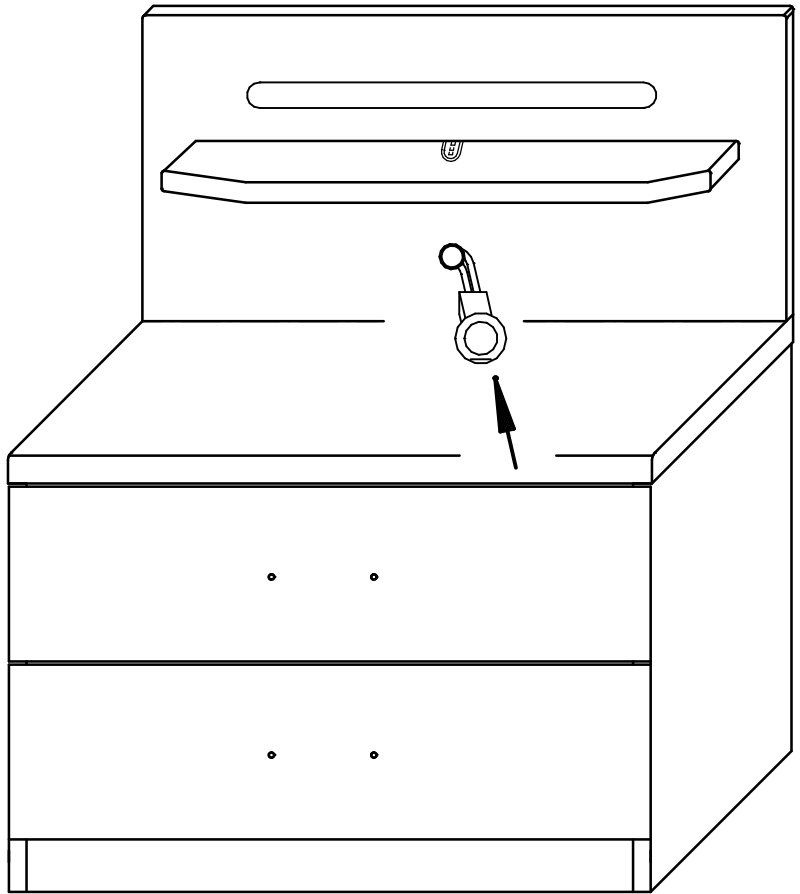

3.

