

A

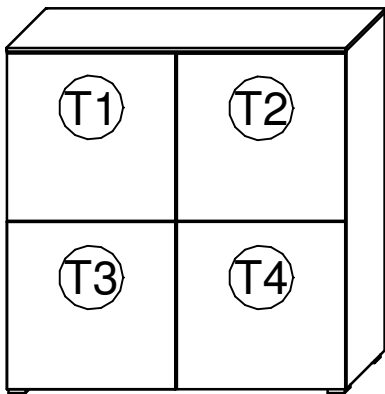

B

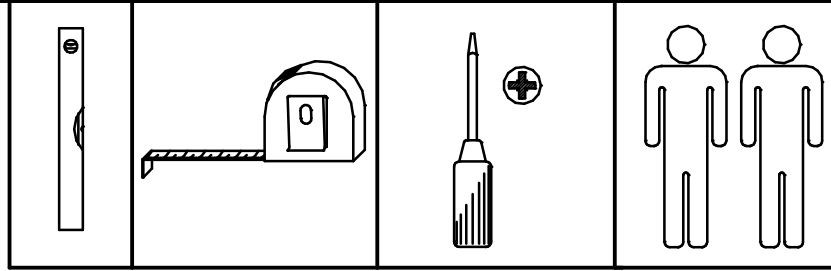
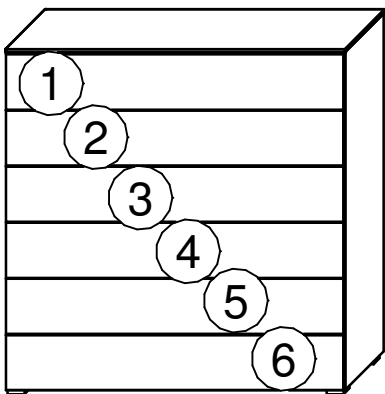
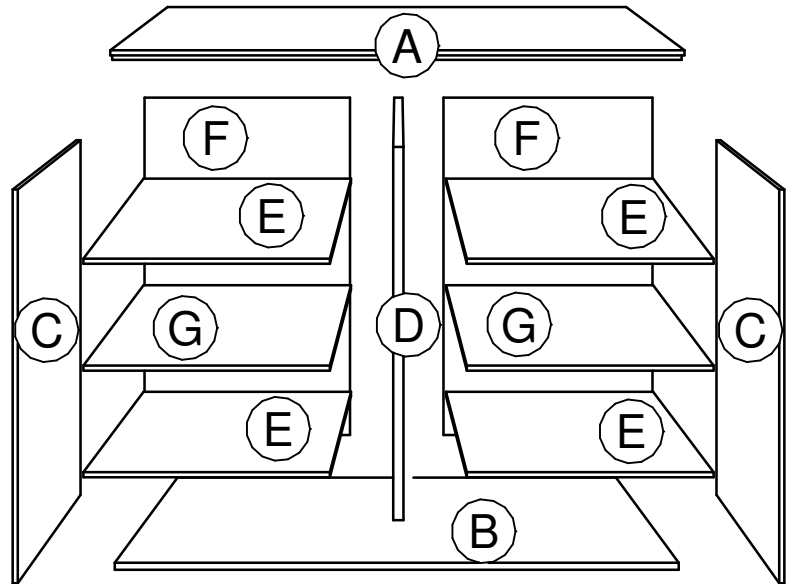

C

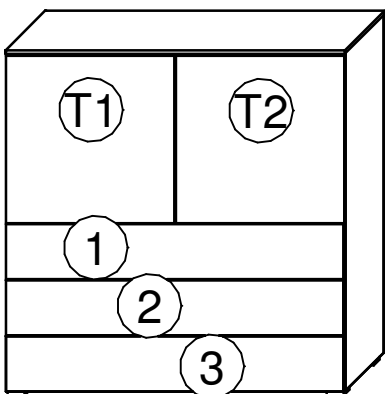

D

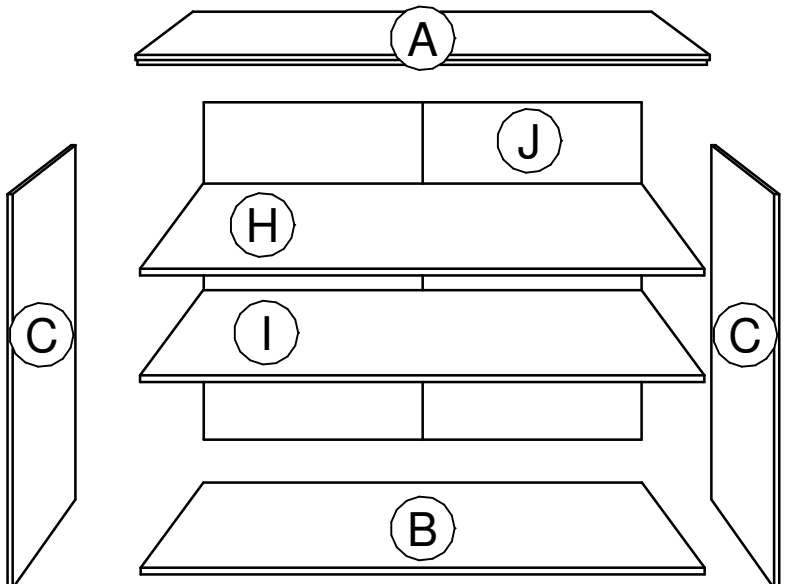

1.

623.0057.000

①

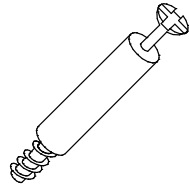

623.0056.000

②



730.1146.000
8 x 30 mm

③

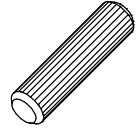

4 x

A + B

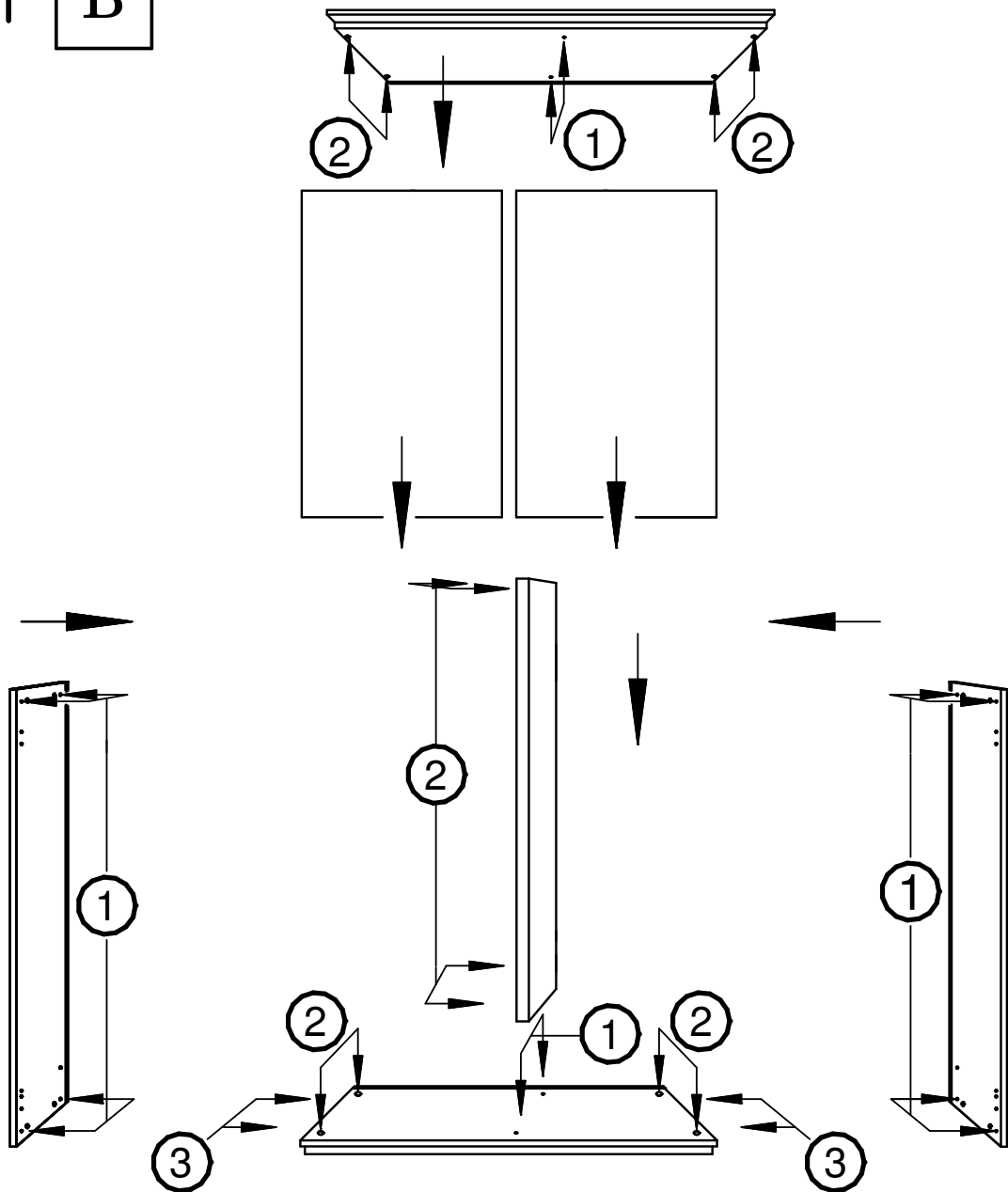

1.

C + D

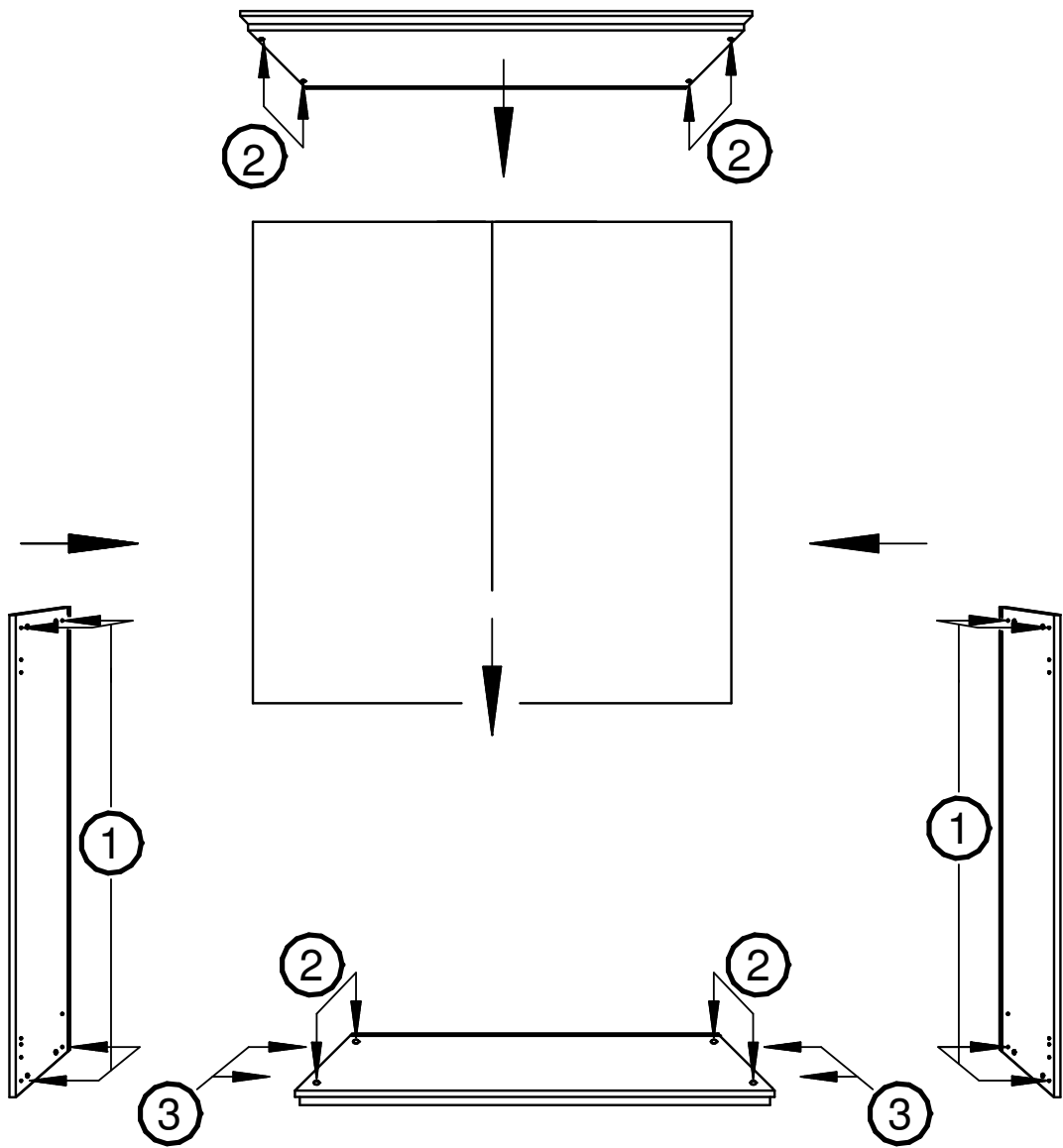

2.

641.0227.000
12 mm

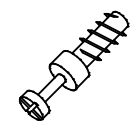

④

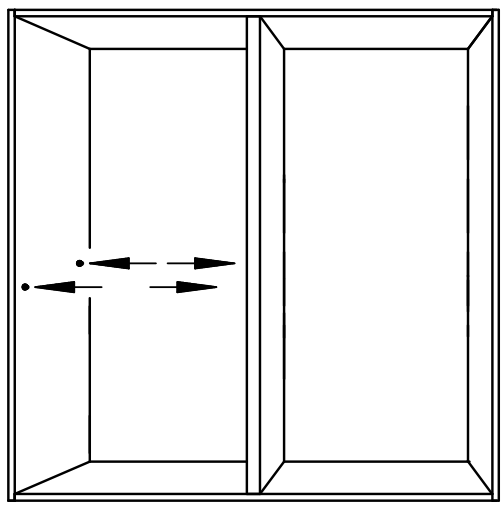

A

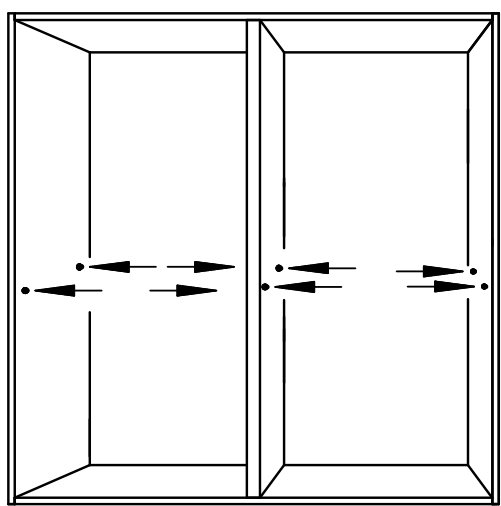

B

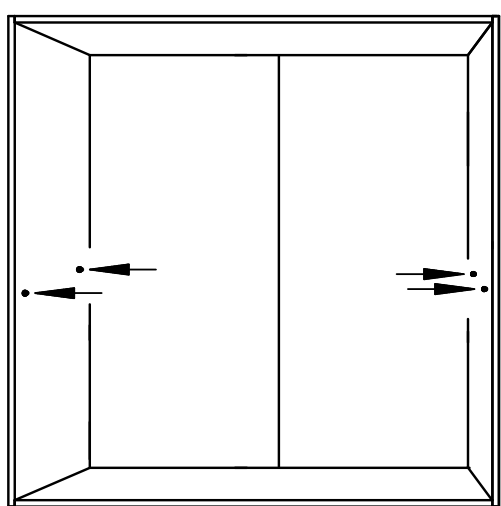

D

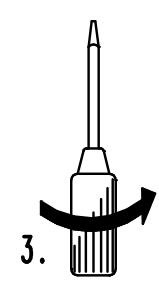
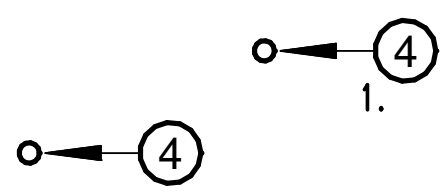
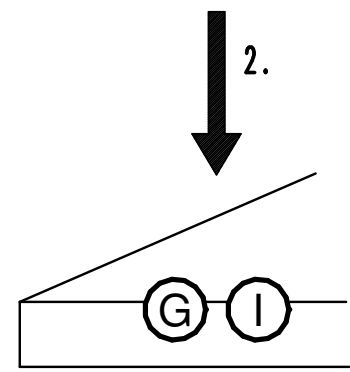

3.

621.1300.000



5

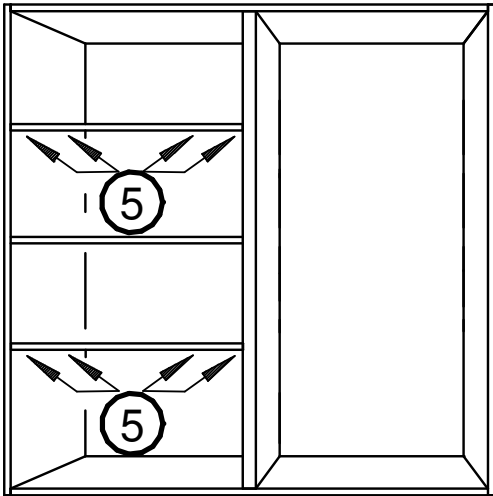

A

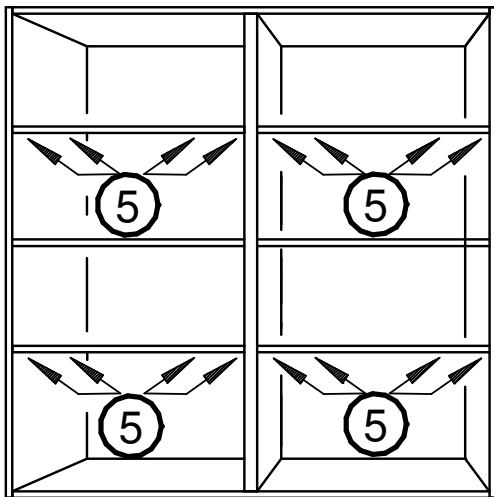

B

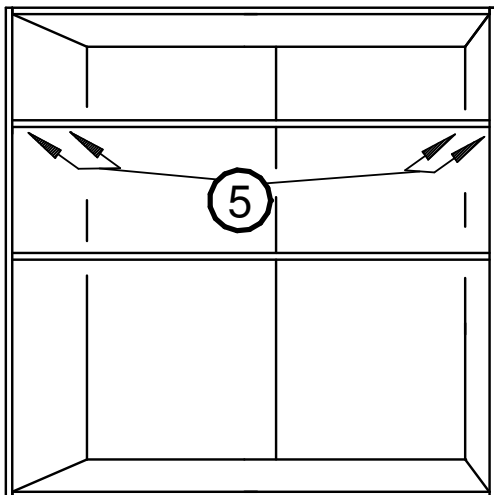

D

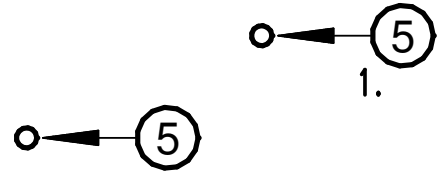
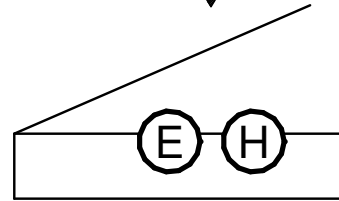
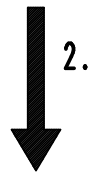

623.0054.000

C + D



6

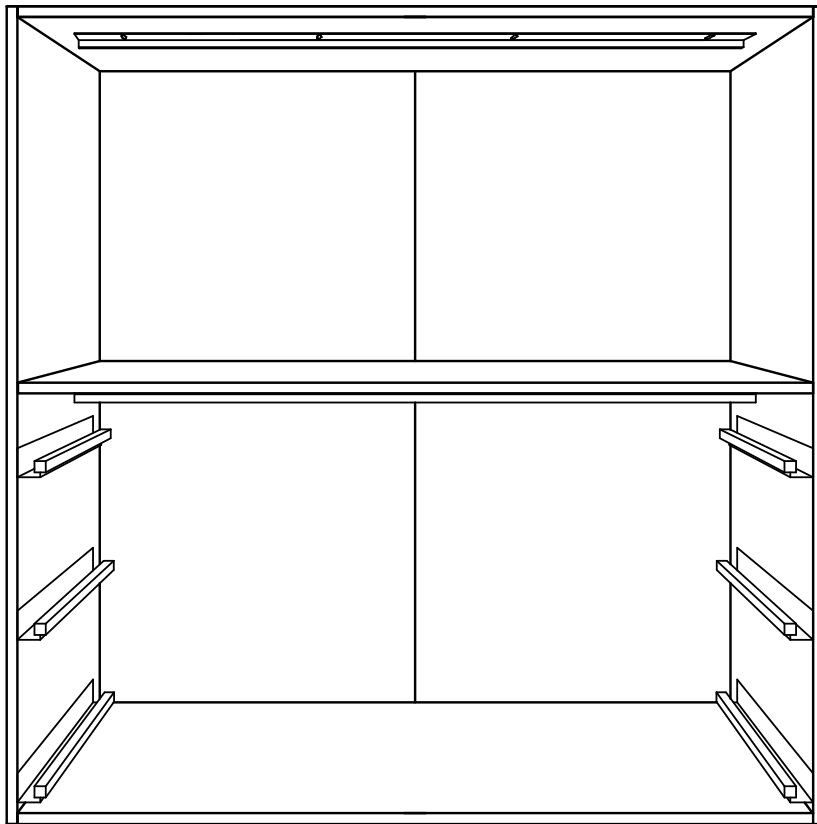

4.

D

6

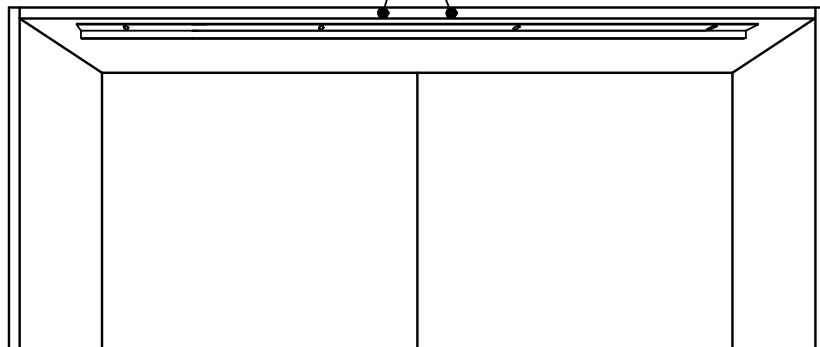

5.

643.0094.000

7

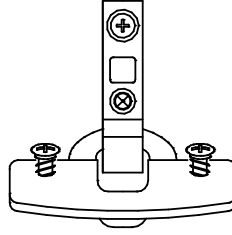

643.0096.000

8

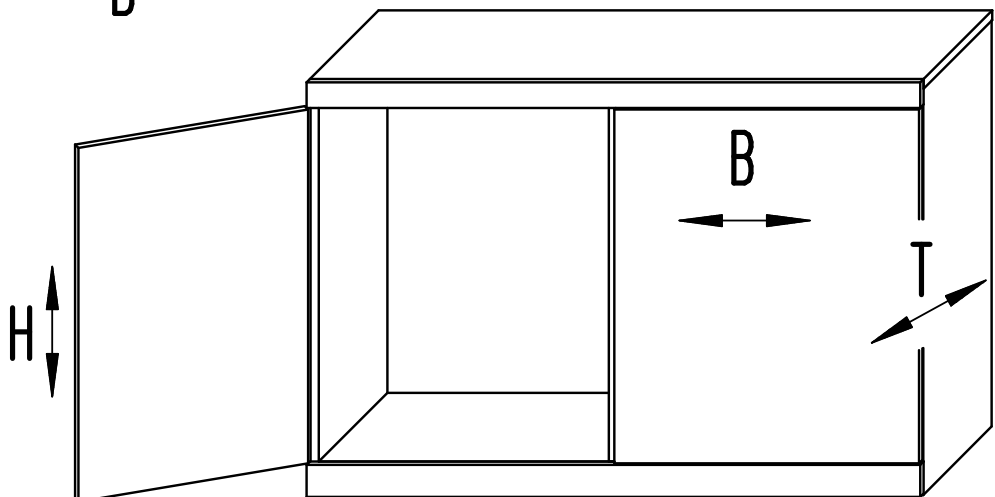
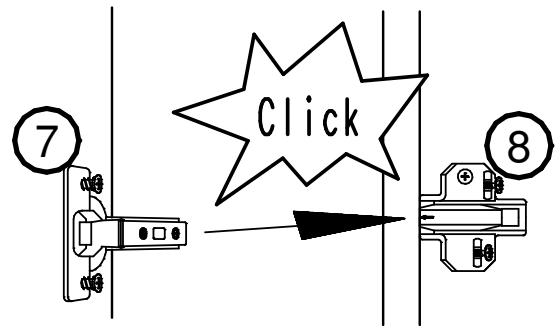
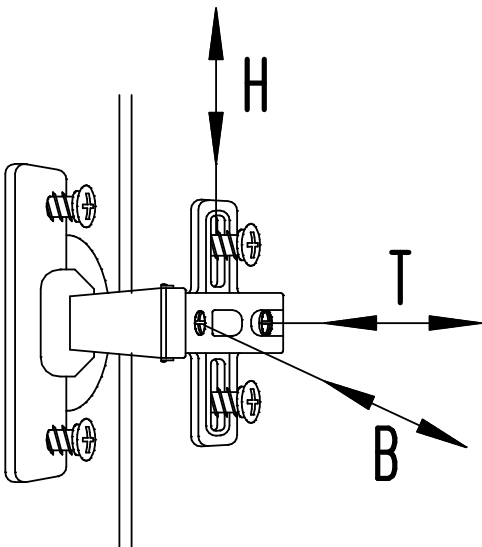
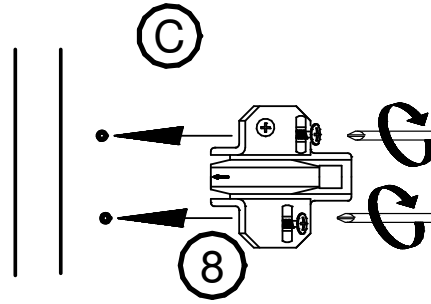
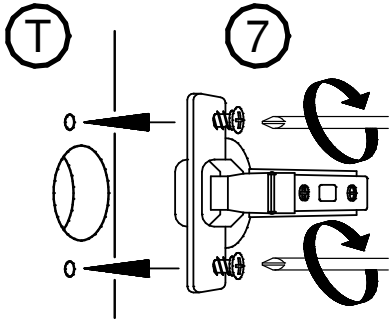
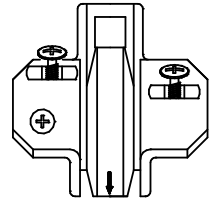

6.

A + B

631.1274.000
3,5 x 20 mm

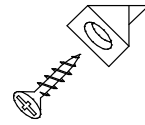

9

631.1504.000
3,5 x 17 mm



10

4 x

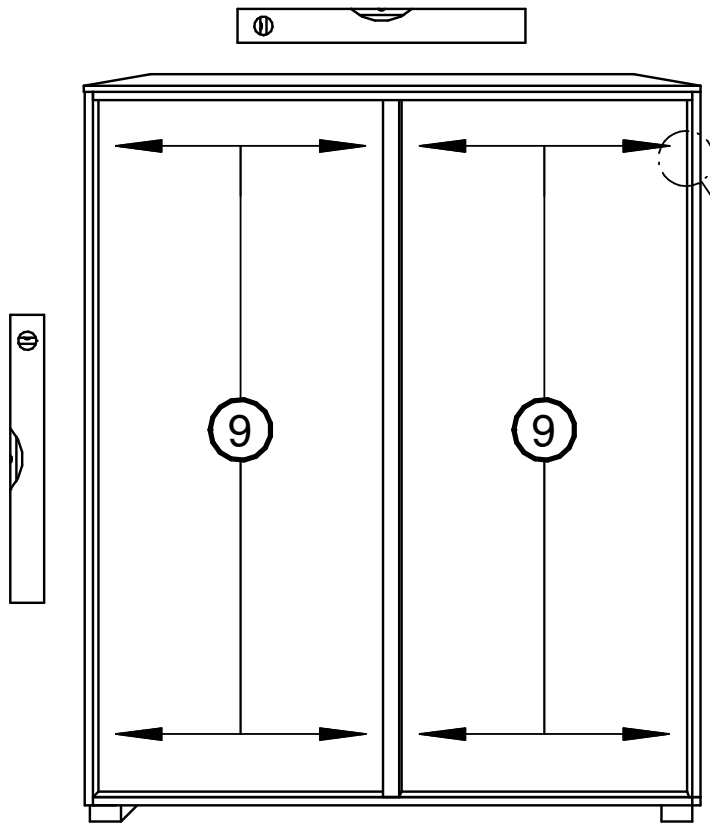

C + D

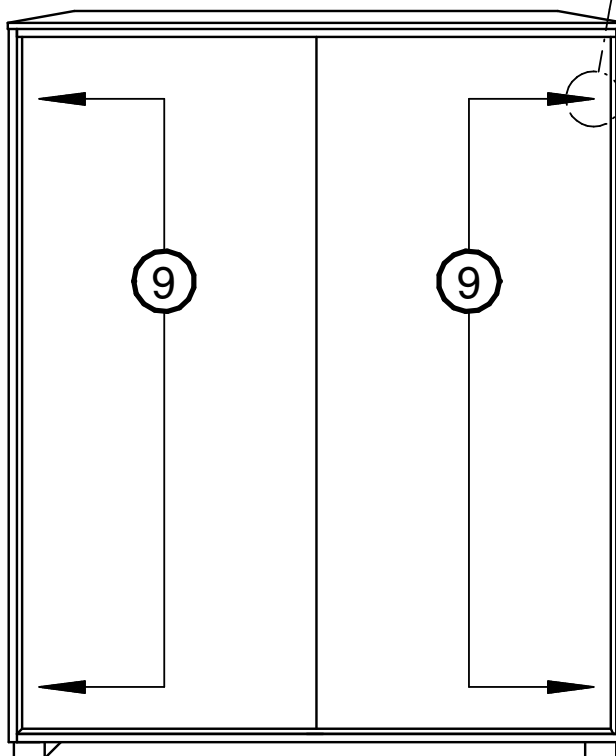

D

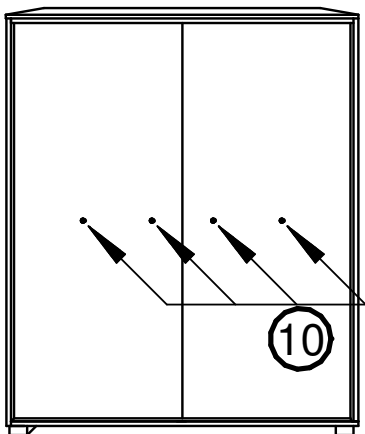

7.

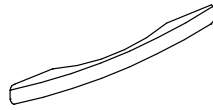

11

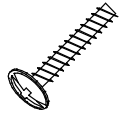

12

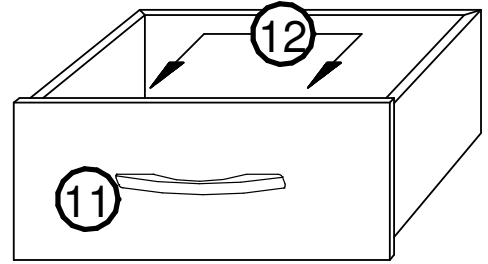
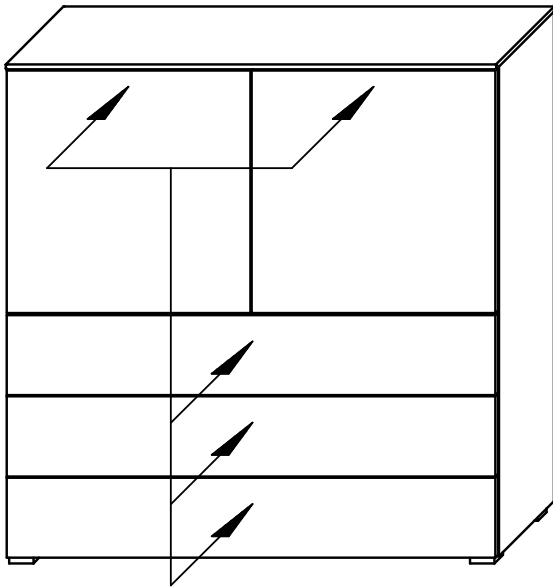

642.0967...

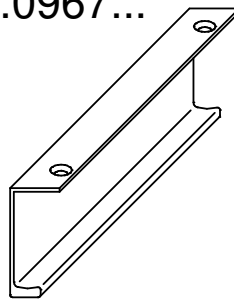

11

631.1472.000
3,5 x 15 mm



12

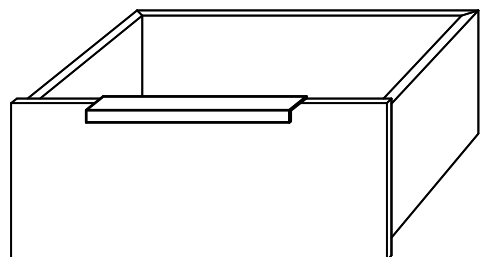
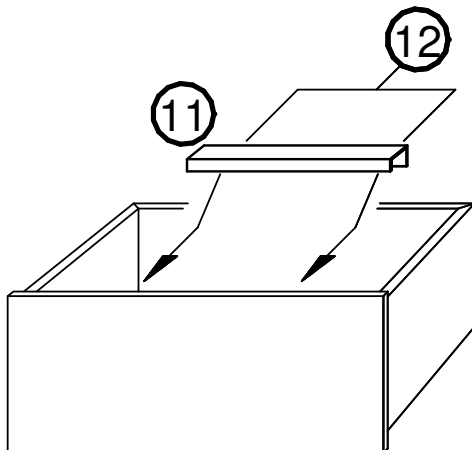

8.

644.0049.000

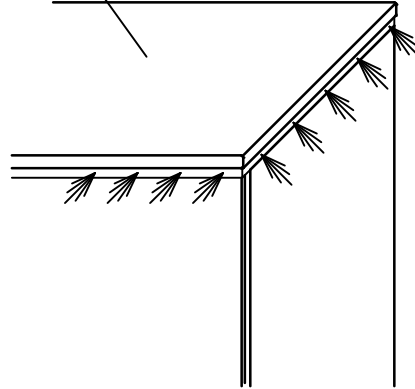
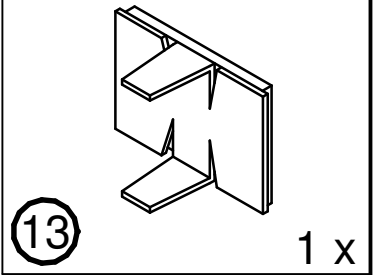
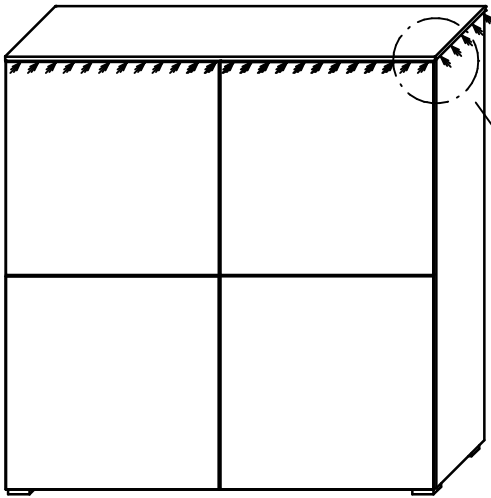

*Dieses Produkt enthält eine Lichtquelle der Energieeffizienzklasse <E>

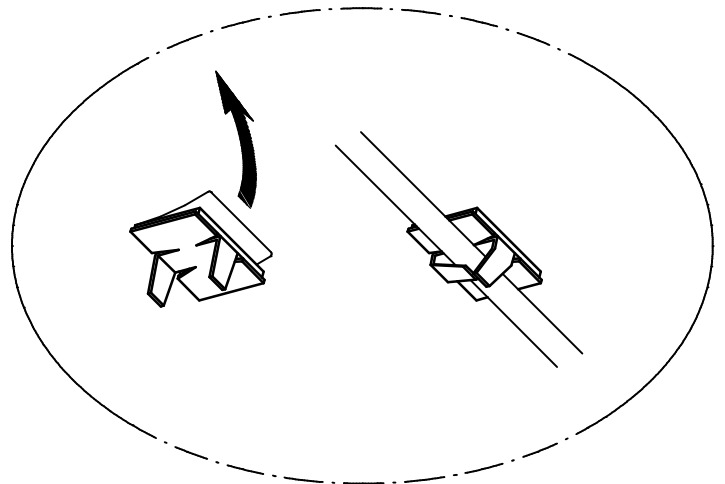
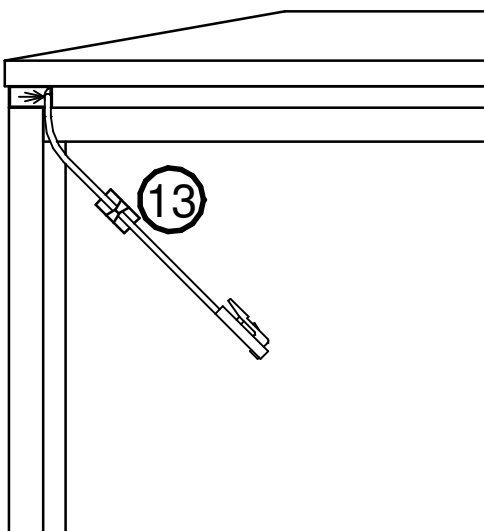
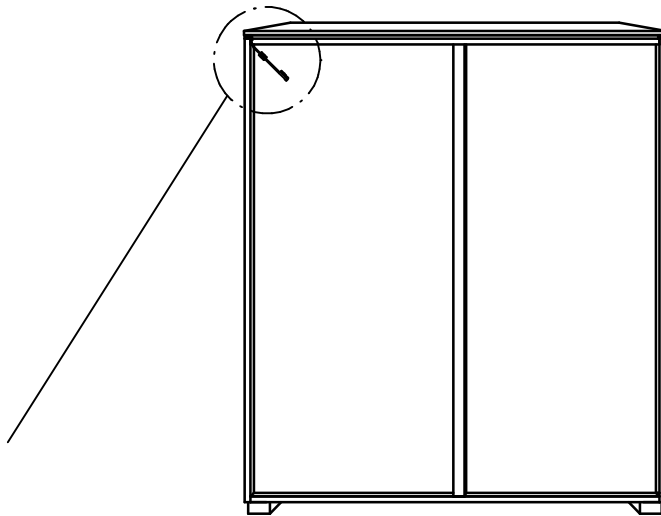

9.

