

T1

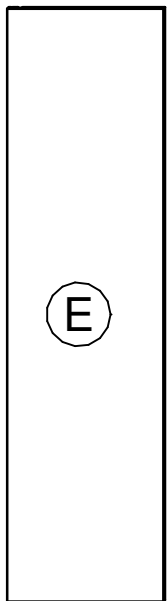

R2

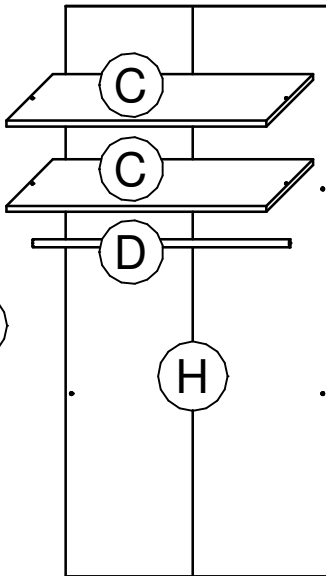
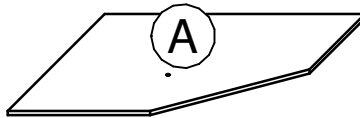
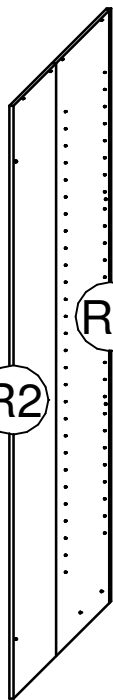

R1

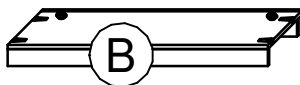

B

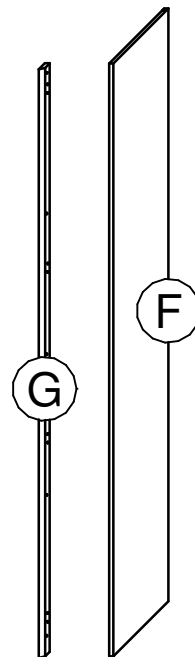

G

F

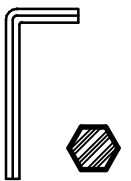
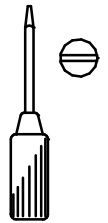
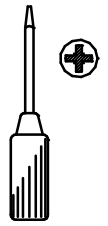
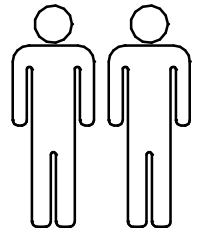

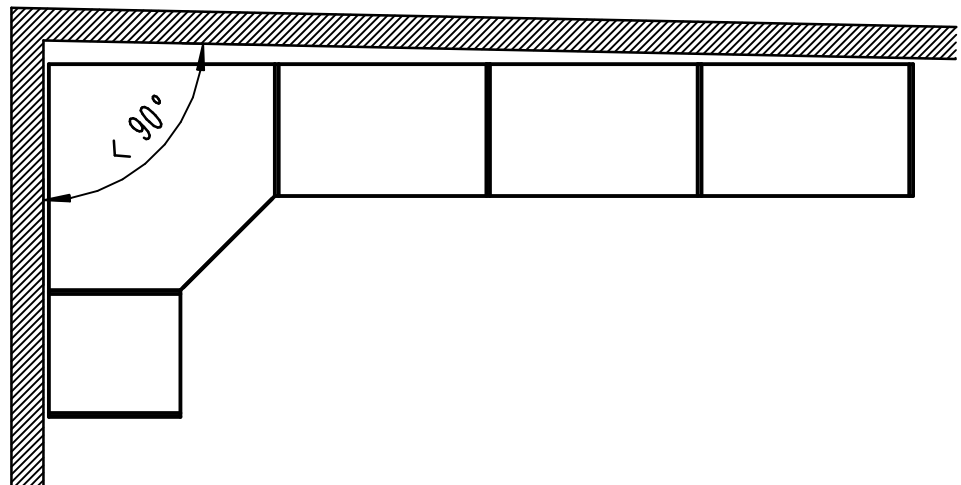
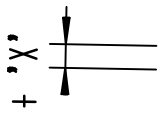
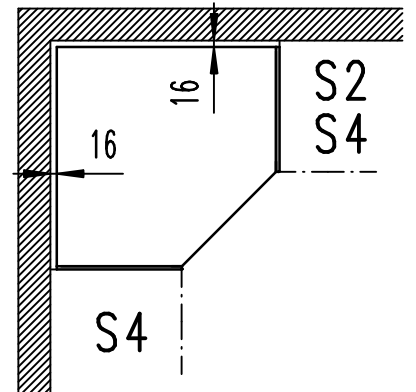
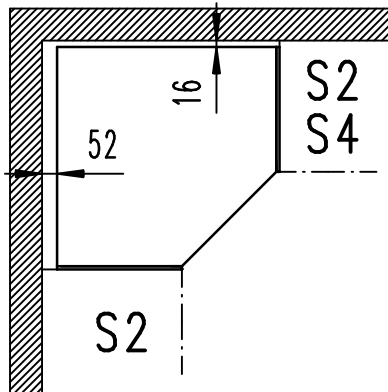
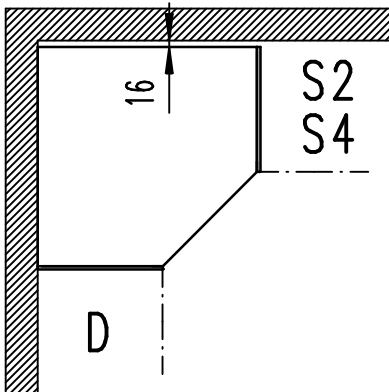
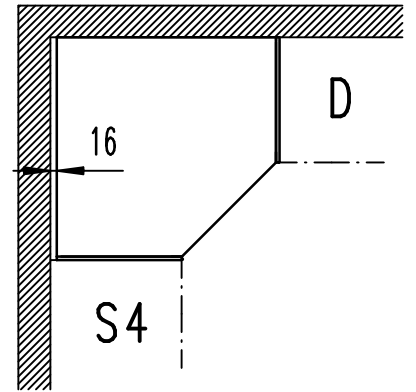
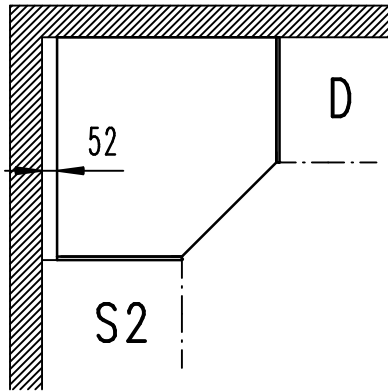
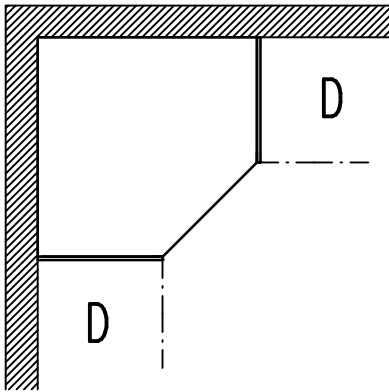
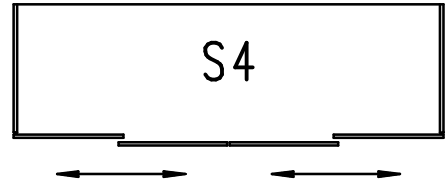
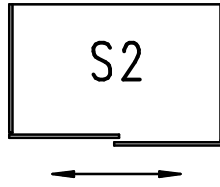
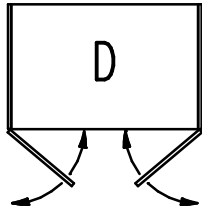

1.

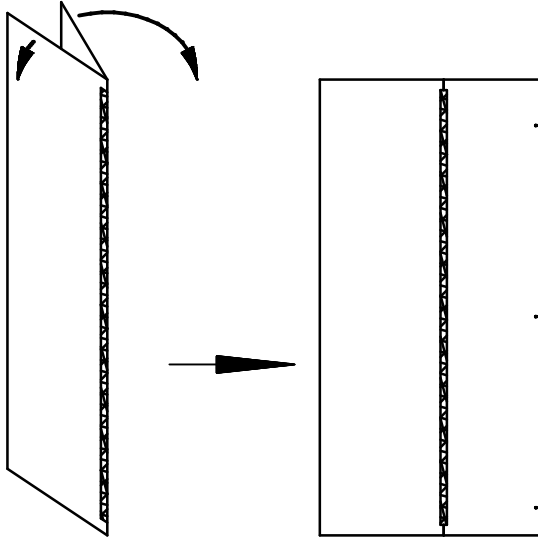

644.0069.000
180 x 30 x 5 mm

① 2 x

631.1504.000
3,5 x 17 mm

② 10 x

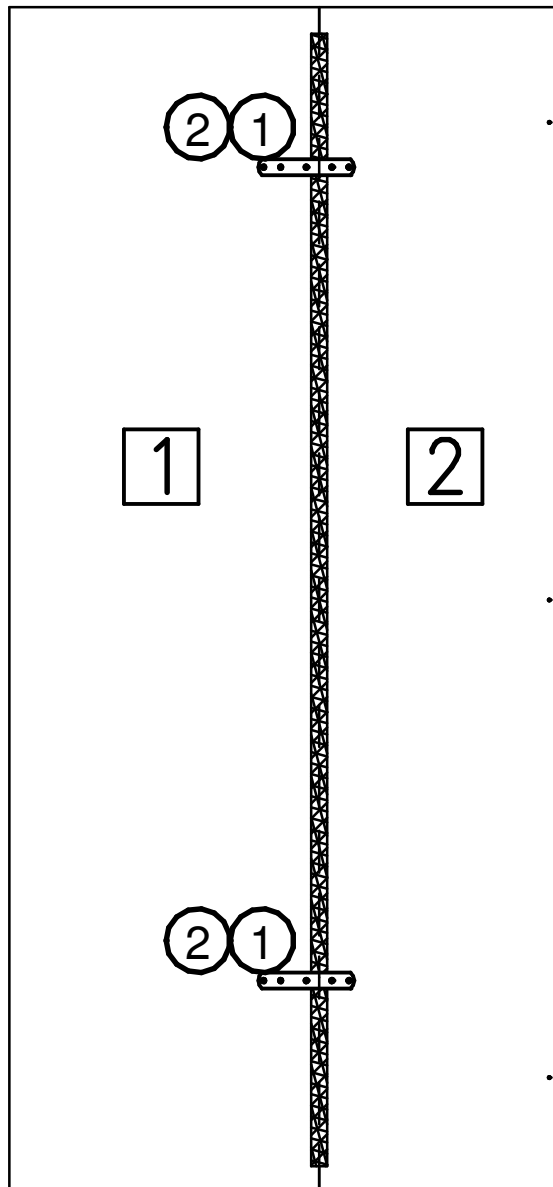

2.

641.0227.000
12 mm

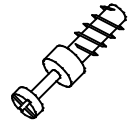

3

12 x

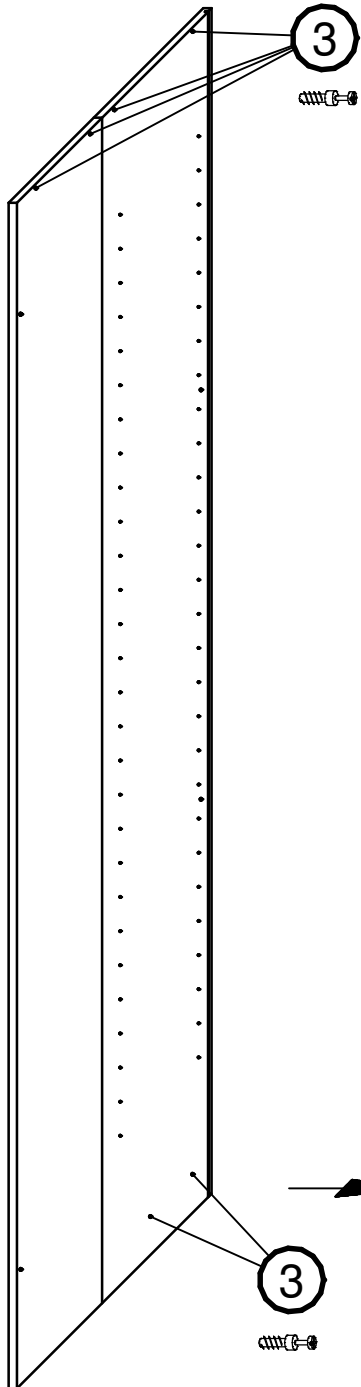

3.

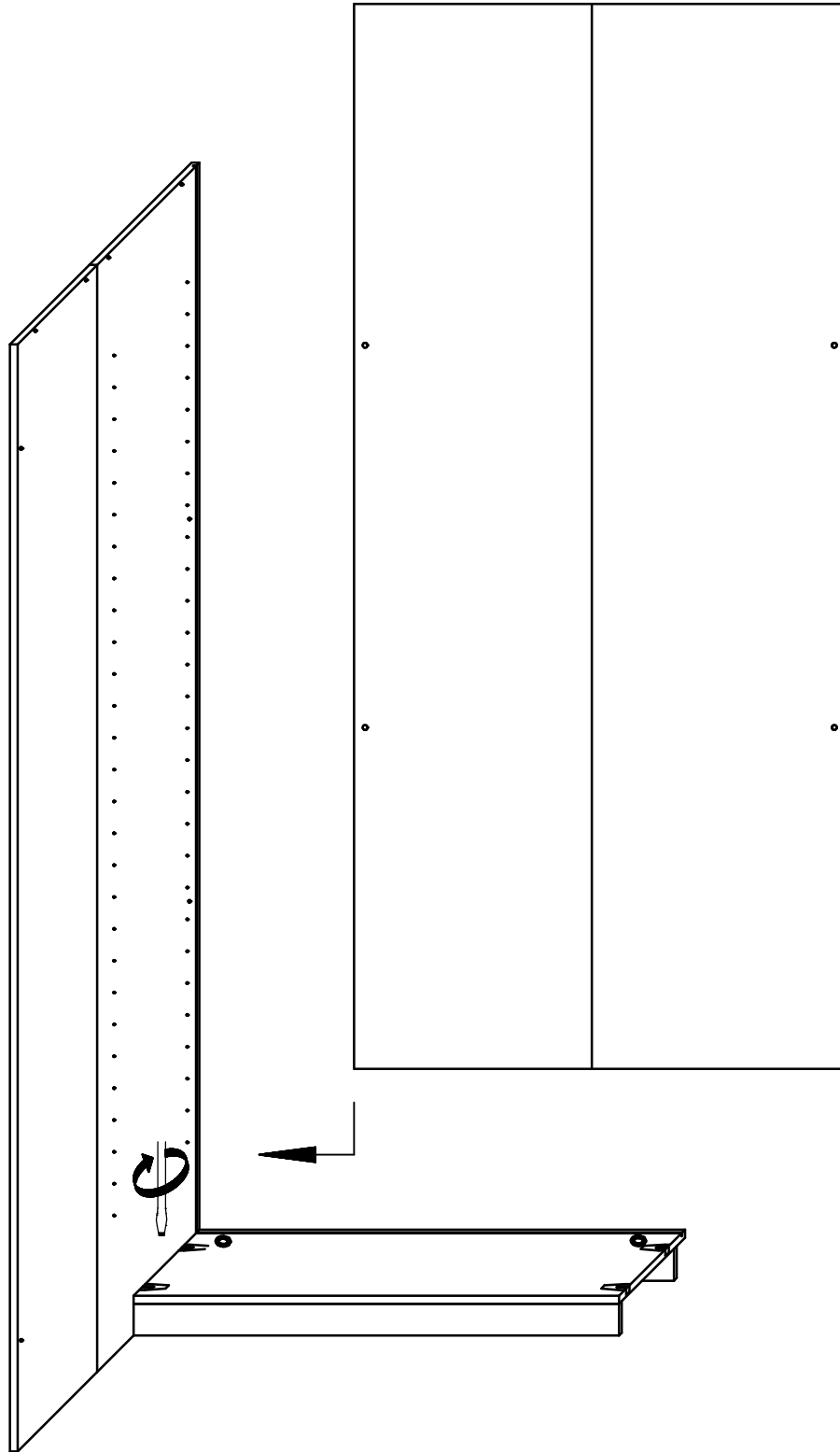

4.

621.2930.000

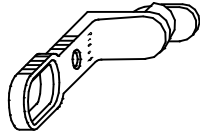

④

4 x

631.1266.000

6,3 x 11 mm



⑤

4 x

631.1472.000

3,5 x 15 mm



⑥

4 x

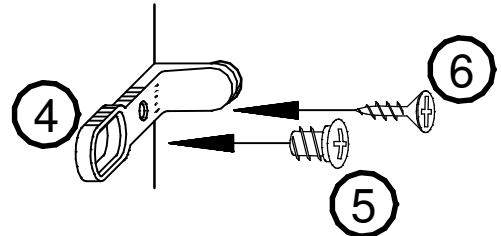
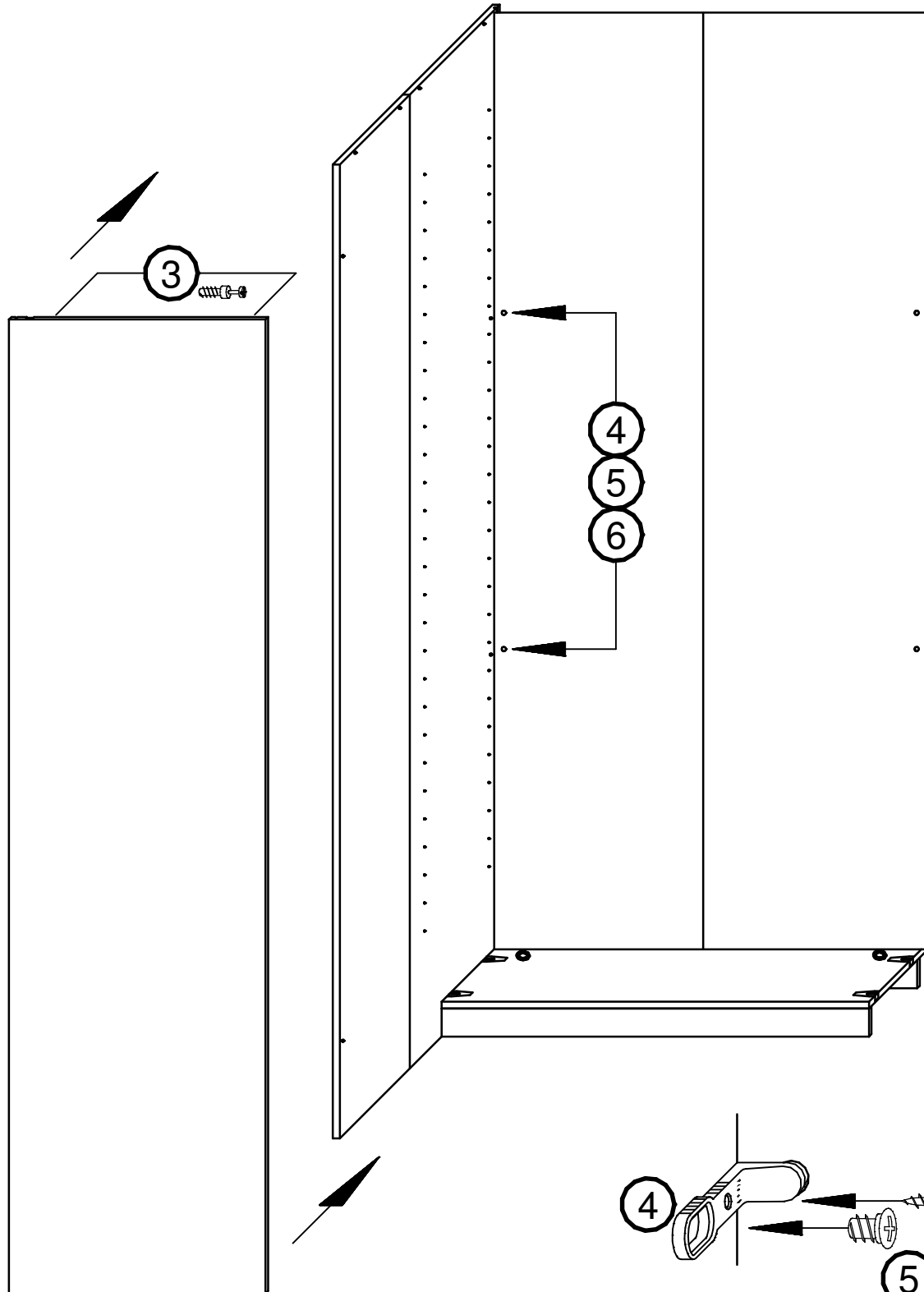

5.

641.0272.000

631.1266.000

6,3 x 11 mm

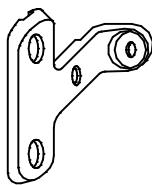

7

3 x

8

9 x

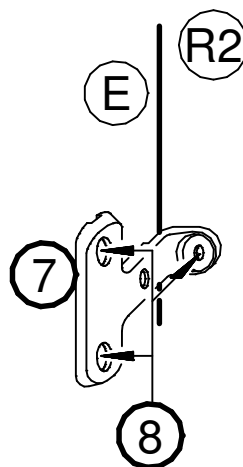
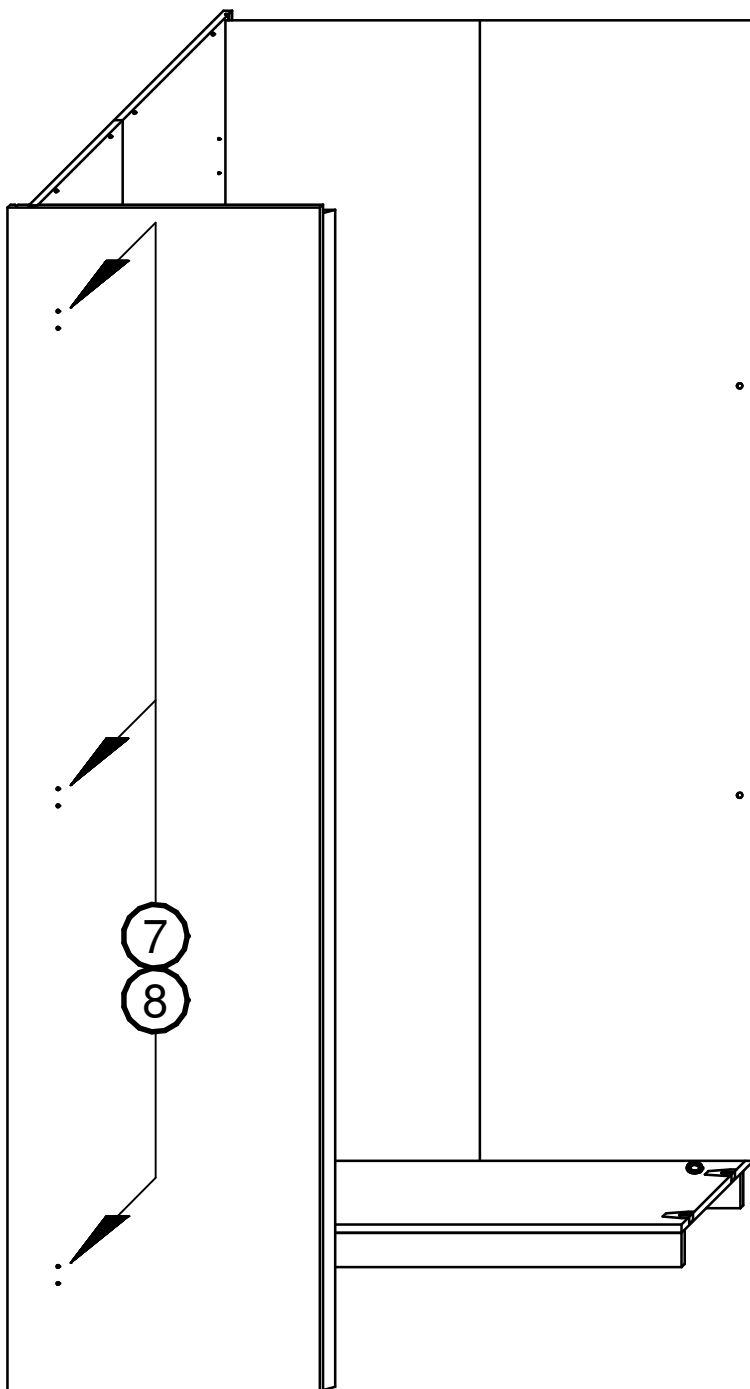

6.

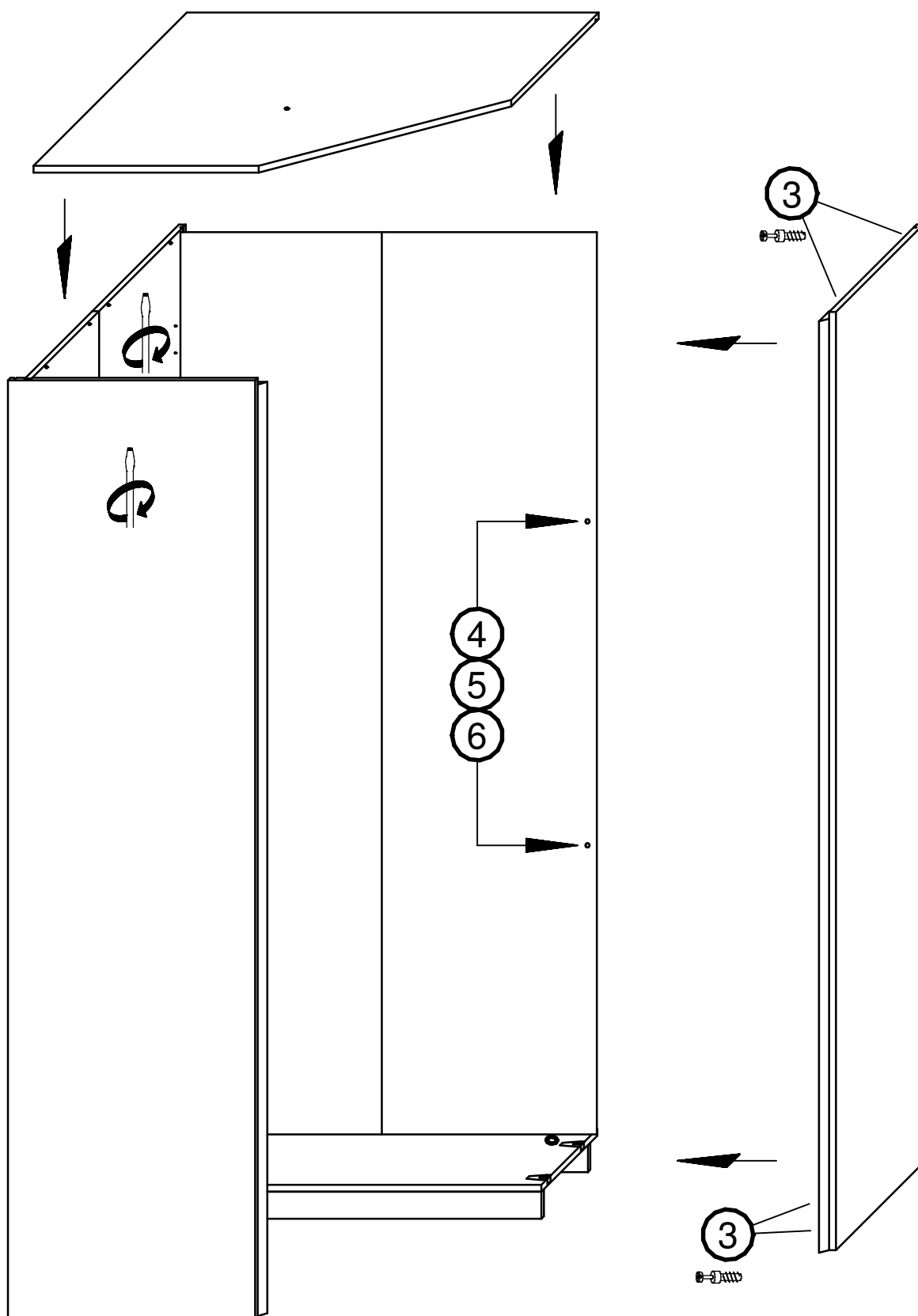

7.

641.0204.000

632.0038.000

4 x 14 mm

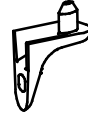

9

8 x

10

8 x

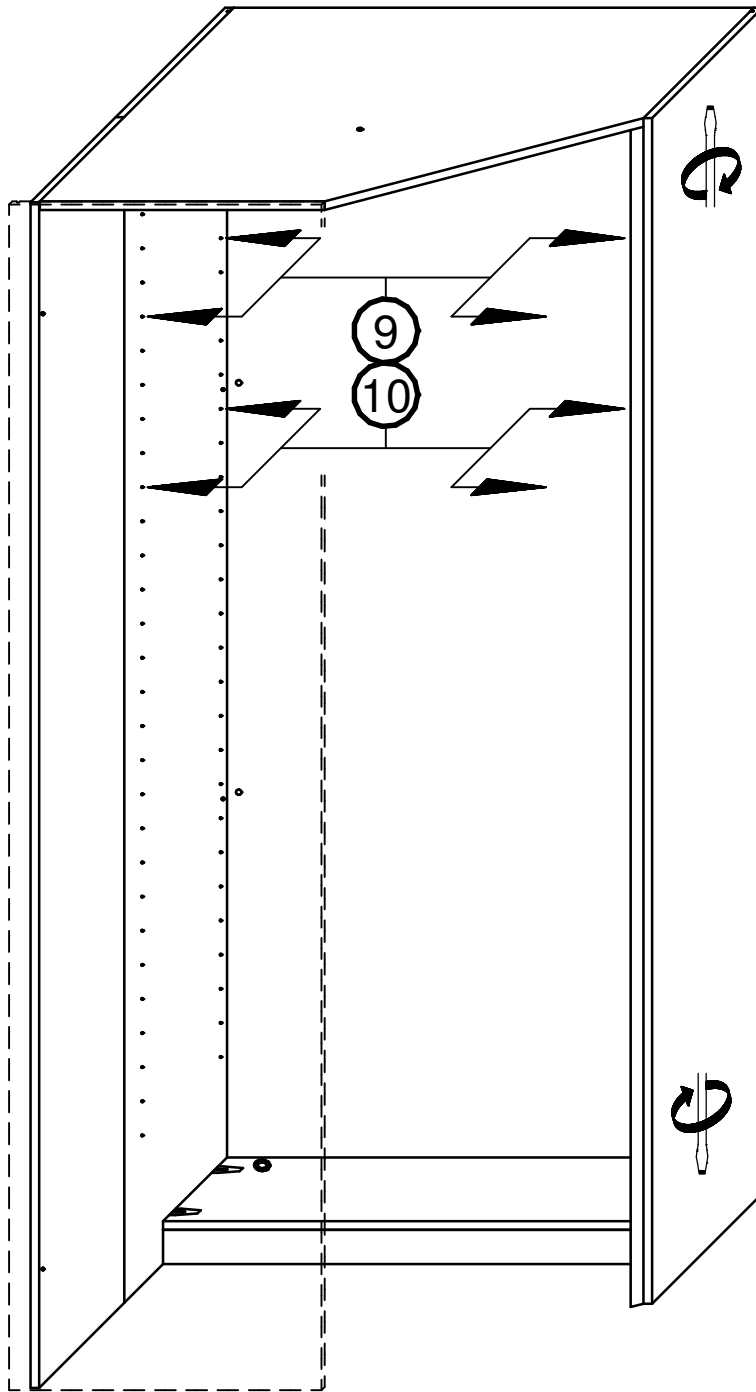

8.

621.0067.000

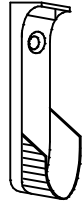

⑪

2 x

632.0517.000

M6 x 30 mm

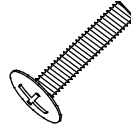

⑫

2 x

631.1472.000

3,5 x 15 mm



⑬

2 x

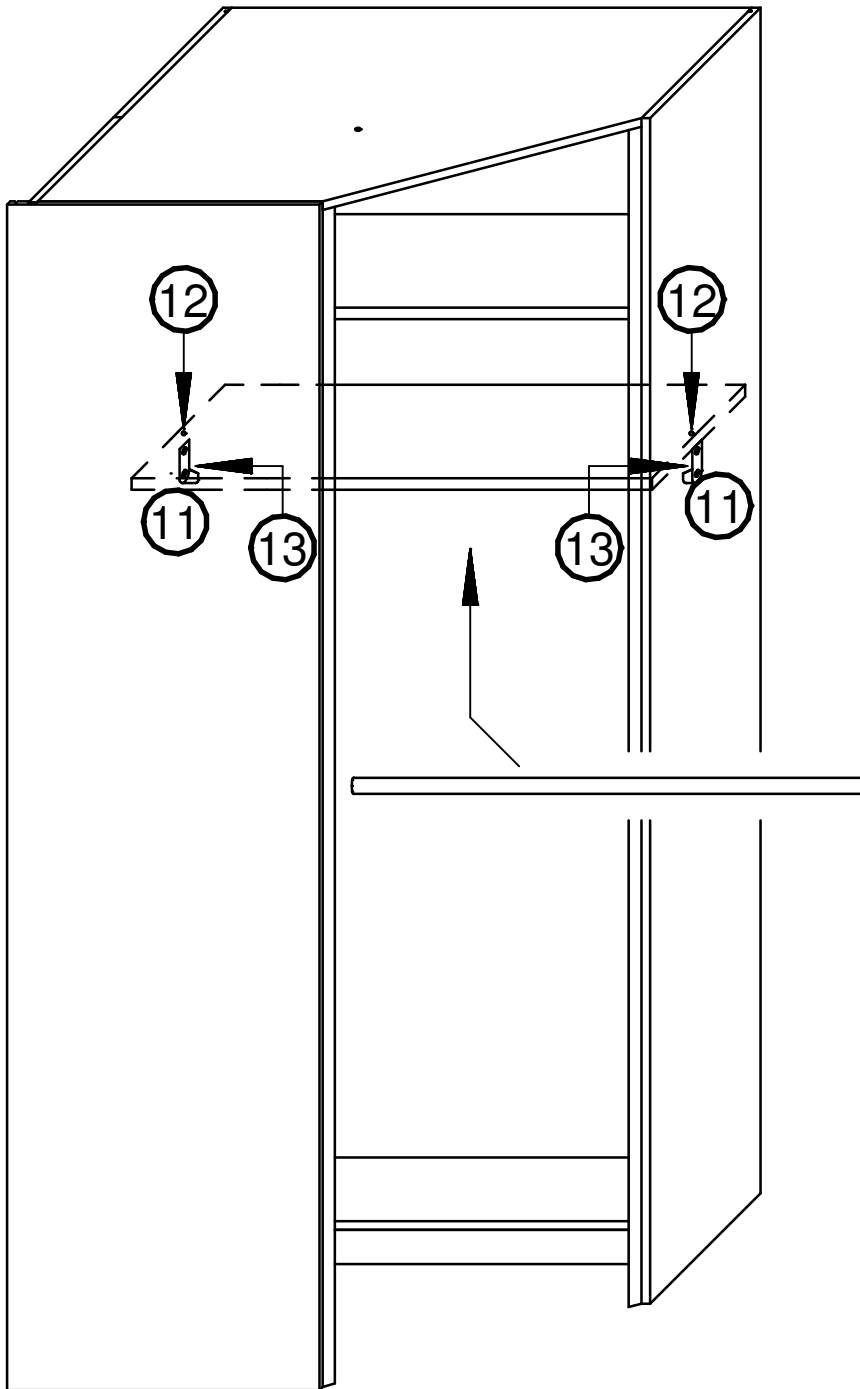

9.

641.0142.000

Ø 8mm



14



15

3 x

16

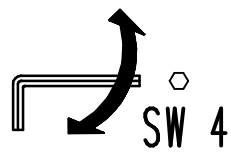
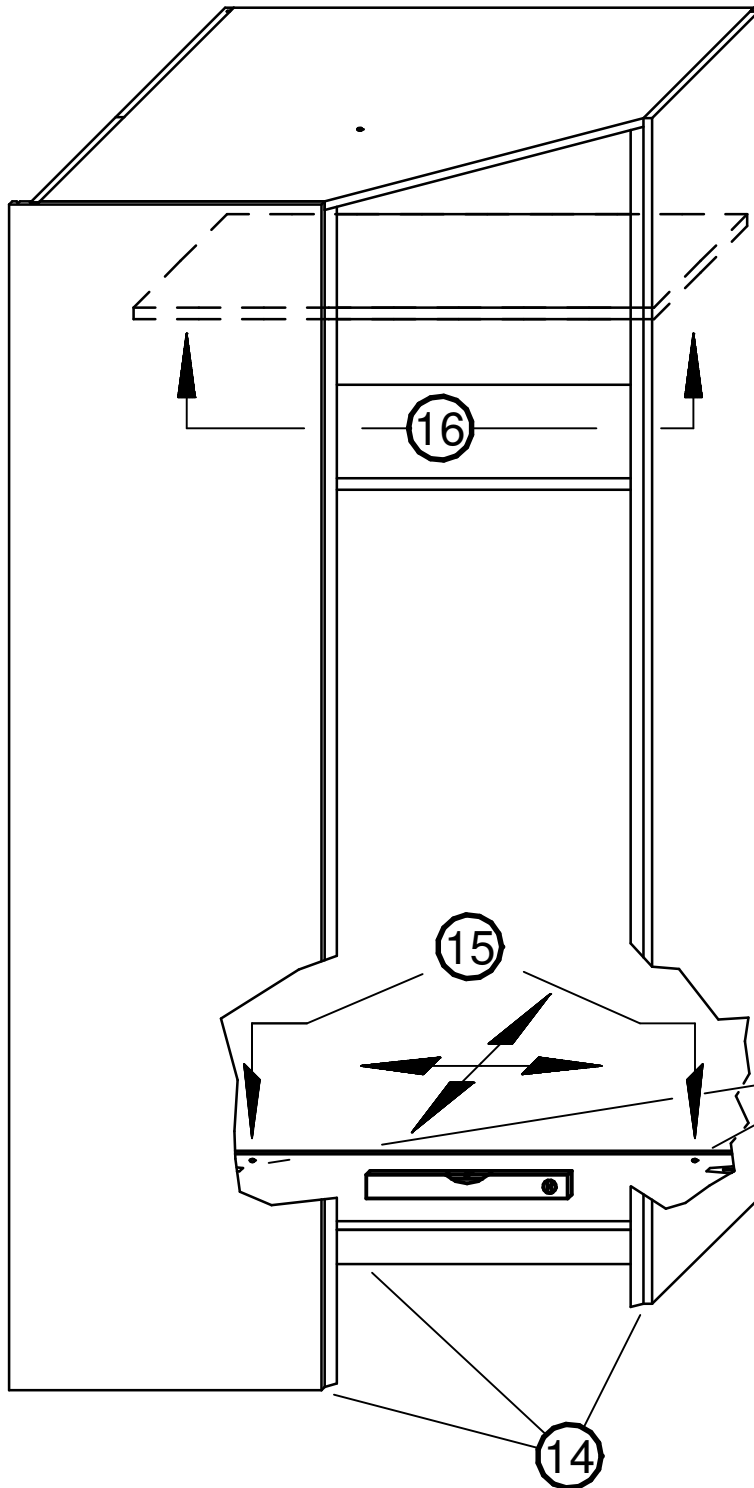
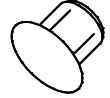

621.2252.000

643.0069.000

45°

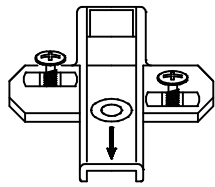
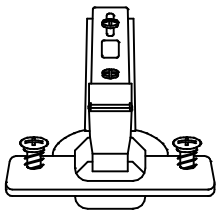

17

4 x

18

4 x

10.

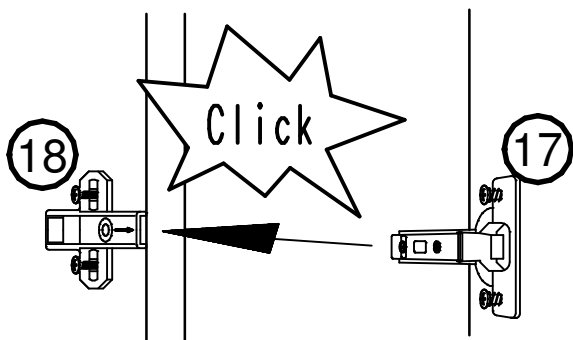
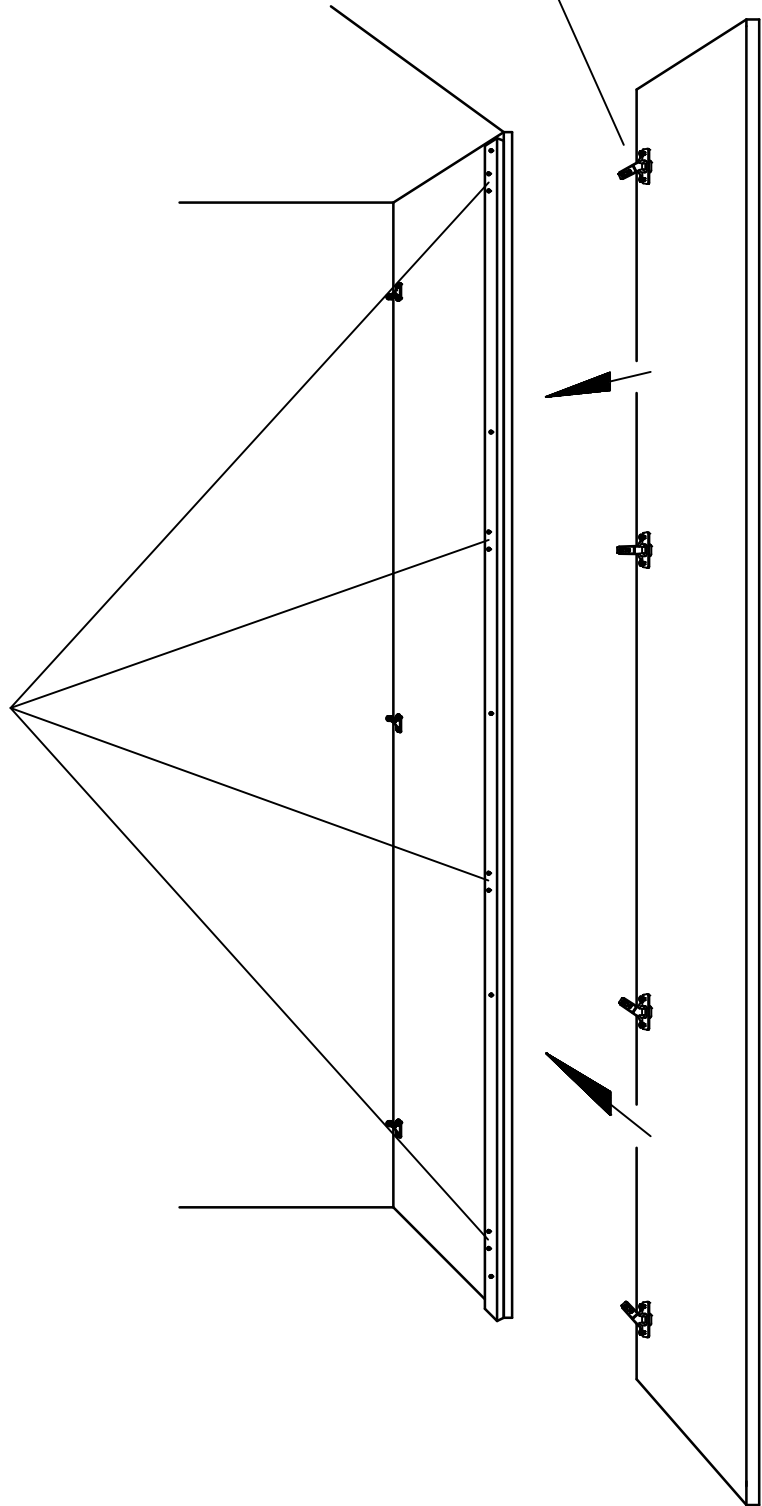
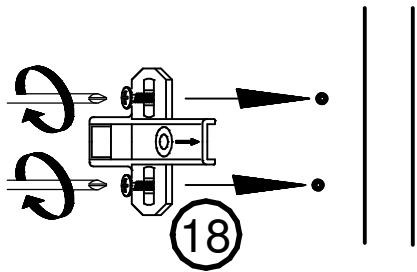
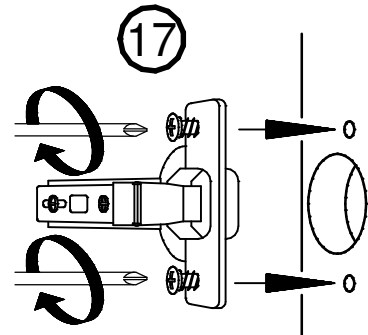

11.

642.0968...

19

1 x

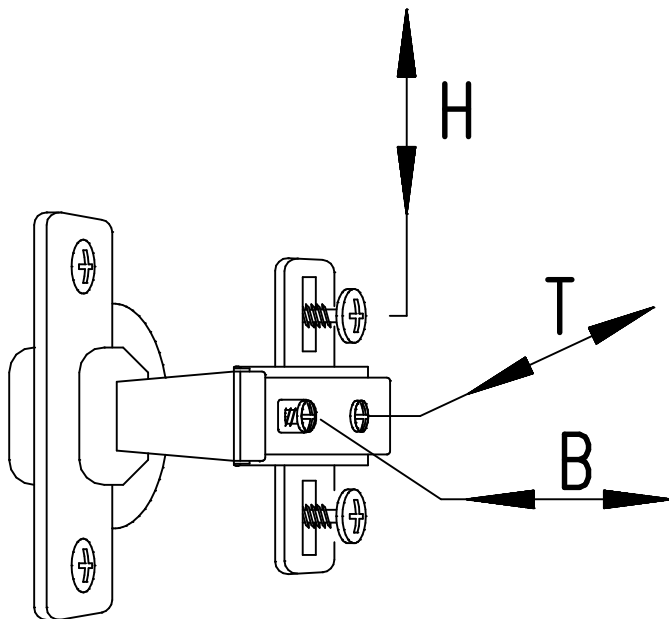
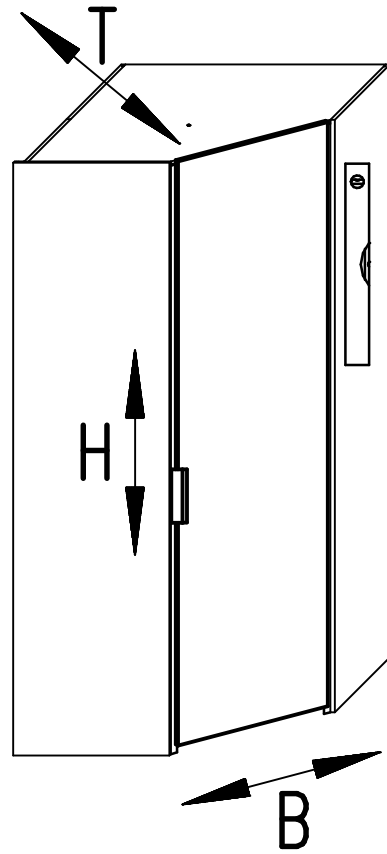
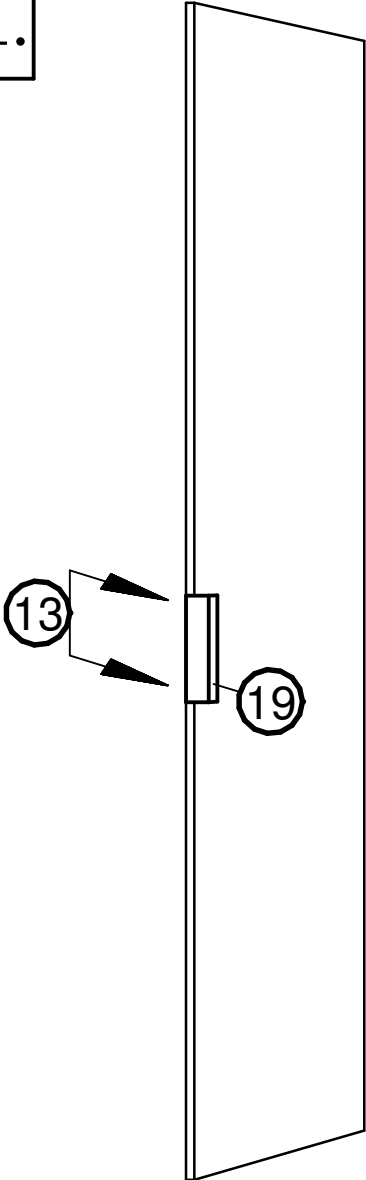
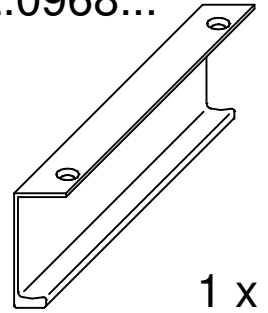

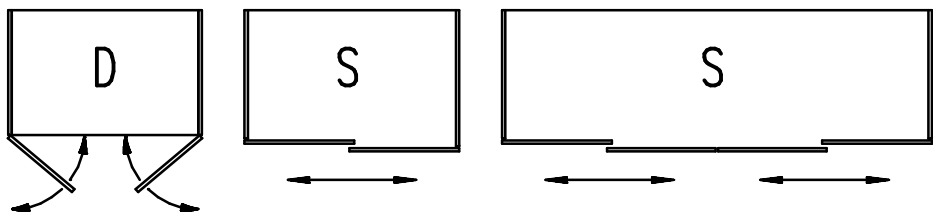
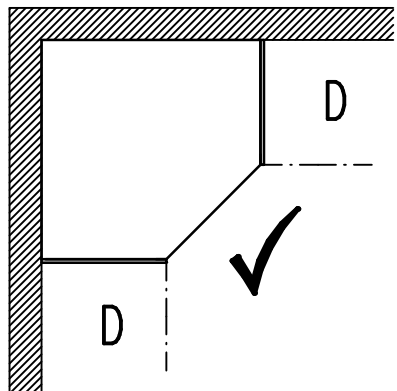

12.

631.1063.000
4 x 35 mm

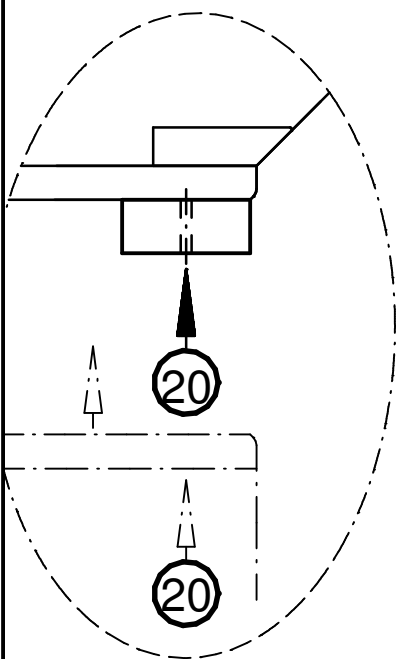
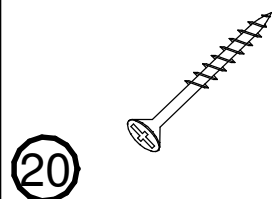

"Y"

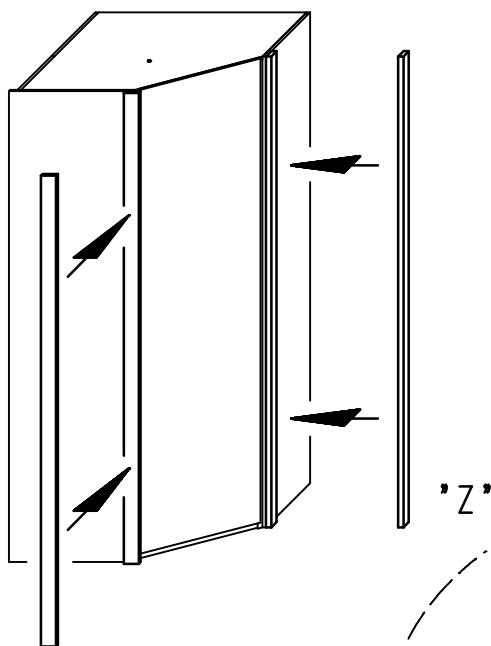

"Z"

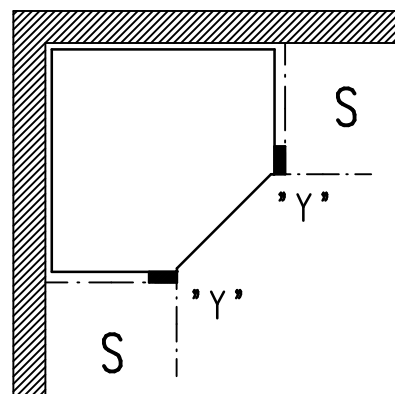
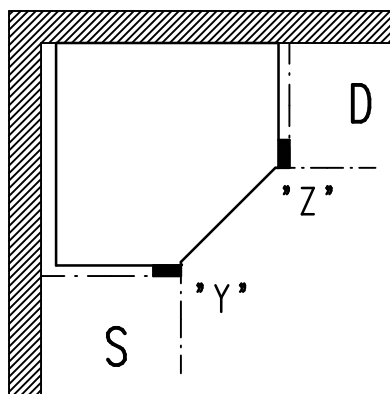
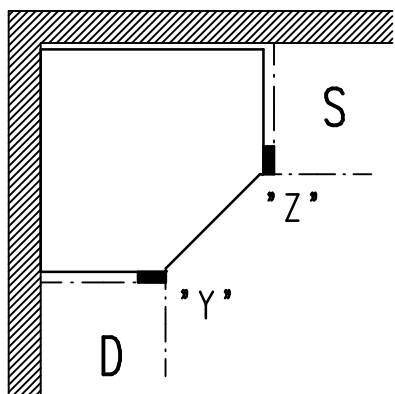
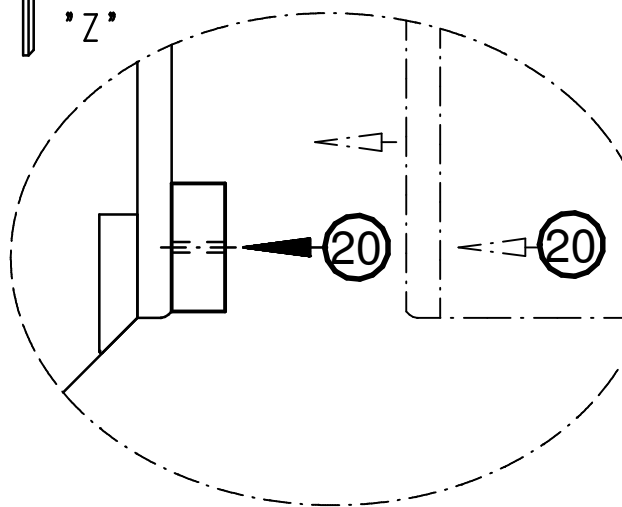

13.

option

Click

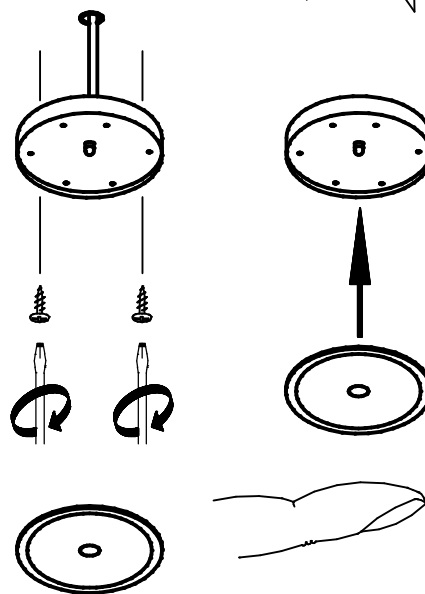
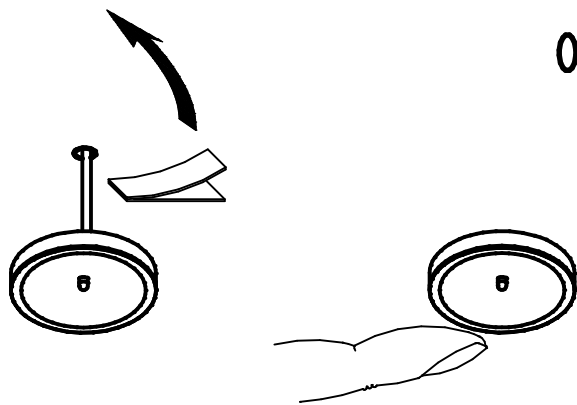

*Dieses Produkt enthält eine Lichtquelle der Energieeffizienzklasse <F>

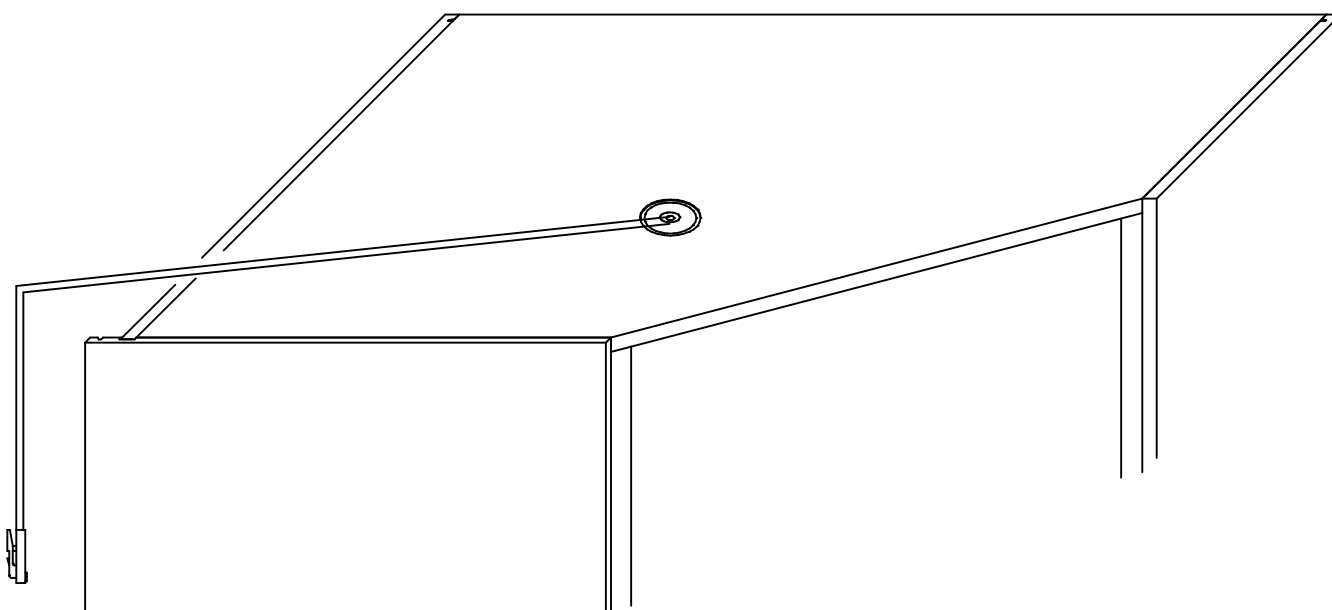

14.

641.0319.000

631.1070.000

3 x 15 mm

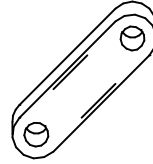

(21)

1 x

(22)

2 x

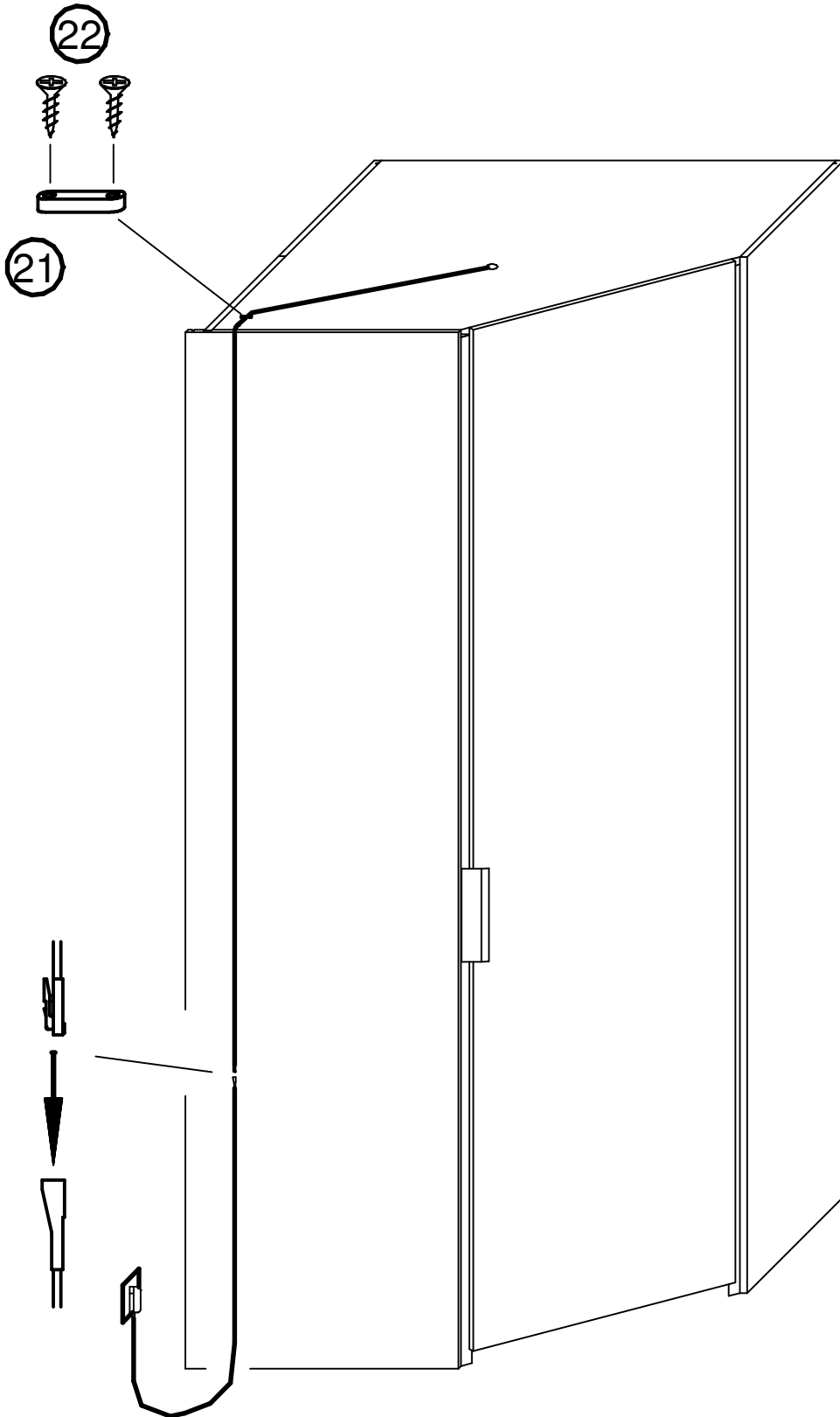

15.

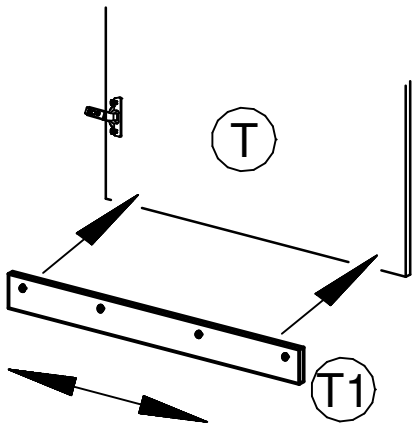
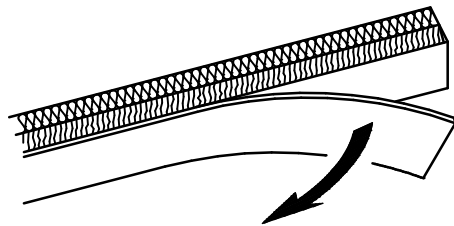
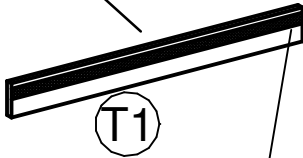
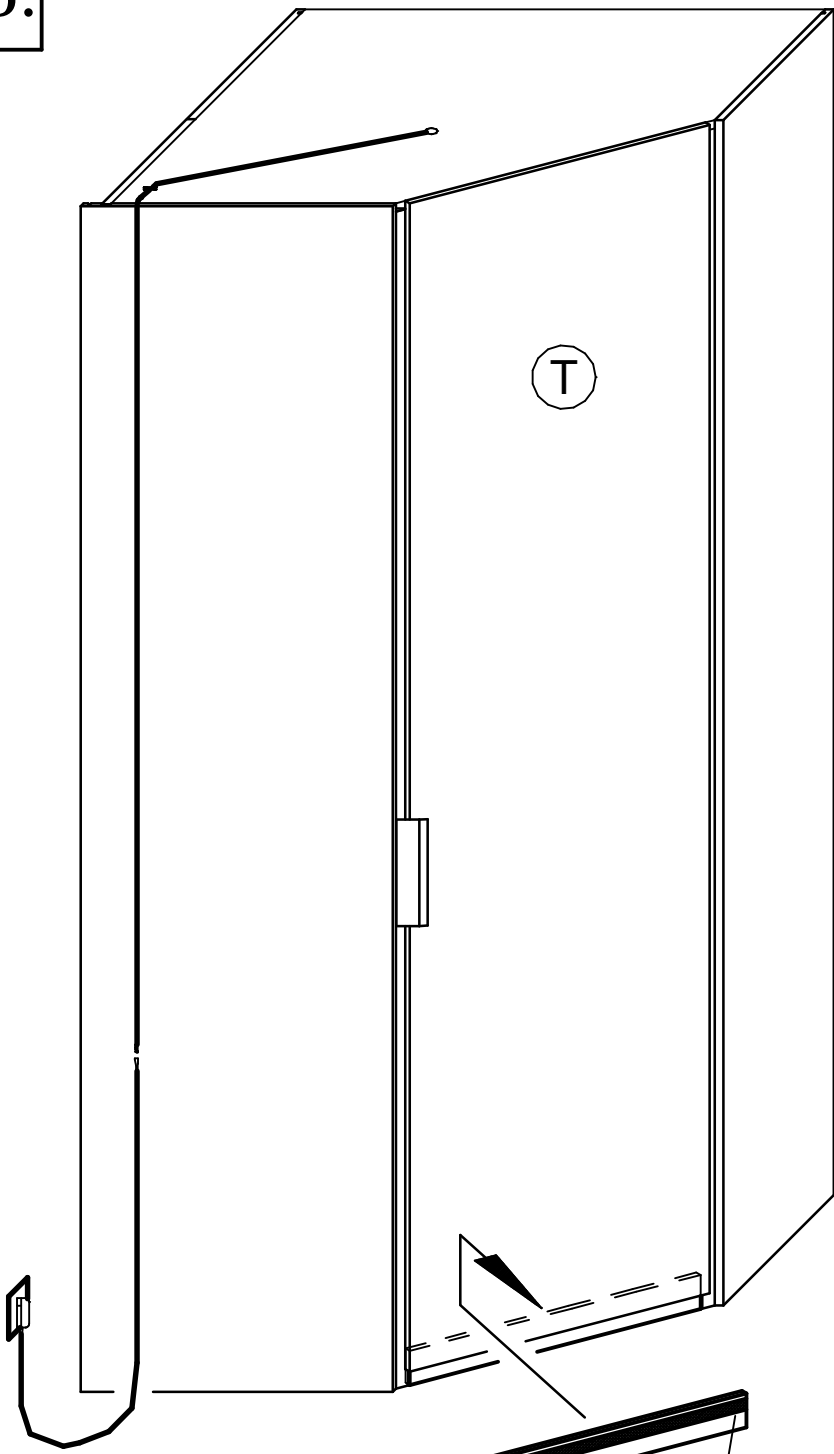

16.

631.1530.000
4 x 30 mm

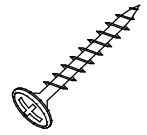

23

4 x

